

# RAILWAY® EQUIPMENT



September 2016

SPECIAL ISSUE  
INNOTRANS  
2016



# UNION OF INDUSTRIES OF



## UIRE Members

- ABB LLC
- Academician N.A. Semikhatov Automatics Research & Production Corporation (NPOA) JSC
- All-Union research and development centre of transport technologies (VNICTT)
- Alstom Transport Rus LLC
- Amsted Rail Company inc
- Armavir Heavy Industries Plant JSC
- ASI Engineering Center LLC
- Association of outsourcing agents NP
- Association of railway braking equipment manufacturers and consumers (ASTO)
- AVP Technology LLC
- Azovelectrostal PJSC
- Azovobschemash PJSC
- Balakovo Carbon Production LLC
- Baltic Conditioners LLC
- Barnaul Car Repair Plant JSC
- Barnaul plant of asbestos technical products JSC
- Belarusian Railways NU
- Bridge R&D Institute FSUE
- Cable Alliance Holding LLC
- Cable Technologies Scientific Investment Center CJSC
- Car Repair Company LLC
- Car Repair Company One JSC
- Car Repair Company Two JSC
- Car Repair Company Three JSC
- Car & Wheel Workshop LLC
- Cars R&D Centre JSC
- Car Building R&D Centre JSC
- Center Priority CJSC
- Certification and Licensing Expert Center LLC
- Chirchik Booster Plant JSC
- Dialog-Trans LLC
- Dielektrik CJSC
- Dolgoprudny Research & Production Enterprise JSC
- ELARA JSC
- Electro C CJSC
- Electro-Petersburg CJSC
- Electromechanics JSC
- Electrospiryamitel JSC
- ELTEZA JSC
- Energoservice LLC
- EPK-Brenco Bearing Company LLC
- EPK Holding Company JSC
- EVRAZ Holding LLC
- Faiveley Transport LLC
- Faktoriya LS
- Federal Freight JSC
- FINEX Quality
- Fink Electric LLC
- Flaig+Hommel LLC
- Freight One JSC
- GEISMAR-Rus LLC
- HARP Oskol Bearing plant JSC
- Harting CJSC
- Helios RUS LLC
- Infrastructure and Education Programs Foundation of RUSNANO
- Institute of Natural Monopolies Research (IPEM) ANO
- INTERCITY Production & Commerce Company LLC
- Izhevskiy Radiozavod (IRZ) JSC
- Kaluga Plant "Remputmash" JSC
- Kalugaputmash JSC
- Kav-Trans CJSC
- Kazakhstan temir zholy RSE
- Kirovsky Mashzavod 1 Maya JSC
- Kremenchug Steel Foundry PJSC
- Kriukov Car Building Works JSC
- Knorr-Bremse Railway Transport Systems Holding CIS LLC
- Kupino Car Repair Company LLC
- LUGCENTROKUZ N.A.S. Monyatovsky PJSC
- Machinery and Industrial Group N.V. LLC
- "Milorem" Michurinsk Locomotive Repair Plant JSC
- Moscow State University of Railway Engineering (MIIT)
- MTZ TRANSMASH JSC
- MuromEnergomash CJSC
- Murom Railway Switch Works JSC
- MYS CJSC
- Nalchik High-Voltage Equipment Plant CJSC
- New Car Repair Company LLC
- NIIAS JSC
- NIIEFA-Energol LLC
- NIPTIEM PJSC
- NPC Springs LLC



# RAILWAY EQUIPMENT (UIRE)

---

- NZTO CJSC
- Oktyabr' Product Corporation FSUE
- OrelKompressorMash LLC
- Ostrov SKV JSC
- Pokrovka Finance LLC
- Power Machines – Reostat Plant LLC
- Profit Centre Plus HC LLC
- Prommashkomplekt LLP
- R&D and Design-engineering Institute of Railway Transport, branch of Ukrainian Railways PJSC
- Radioavionika JSC
- Rail Commission NP
- RailMatik LLC
- RailTransHolding Group LLC
- RDC Informational technologies LLC
- RDC Privod-N CJSC
- RDM-contact LLC
- “Ritm” Tver Brake Instrument Production JSC
- RM Rail Holding company LLC
- Roslavl Car Repair Plant JSC
- RPC Dynamics LLC
- RPC INFOTRANS JSC
- RPC United Wagon Company (UWC) PJSC
- RPC Uralvagonzavod JSC
- Russian Railways JSC
- Russian Register Certification Association
- RZD Trading Company JSC
- Samara State University of Railway Engineering (SamGUPS)
- Saransk Car Repair Plant (SVRZ) JSC
- Scientific Instruments JSC
- Schaeffler Russland LLC
- SDS-MASH Holding Company
- SE Plant Electrot'yazhmash
- Sespel Enterprise of Cheboksary CJSC
- SG-Trans JSC
- Siberian Certification Center – Kuzbass LLC
- Siemens LLC
- Sinara – Transport Machines (STM) JSC
- SKF Tver LLC
- SPA RoSAT CJSC
- SPA SAUT LLC
- SPC Electromashina JSC
- SPC Dolomant CJSC
- Special Design Turbochargers Bureau (SKBT) JSC
- SPE Smelyansky Electromechanical Plant LLC
- SSAB Swedish Steel CIS LLC
- Stakhanov Car Building Plant (SVZ) JSC
- Start Product Corporation FSUE
- Svetlana-Optoelectronika CJSC
- Sudotechnologiya Industrial Export Company CJSC
- T-Express CJSC
- TATRAVAGONKA JSC
- Technotrade LLC
- Teploservice LLC
- Tikhoretsk Machine Construction Plant (TMCP V.V.Vorovsky) JSC
- Tikhvin Car Building Plant (TVSZ) JSC
- Timken-Rus Service Company LLC
- Titran-Express – Tikhvin Assembly Plant CJSC
- Togliatti State University
- Tomsk Cable Factory LLC
- TPF RAUT LLC
- TransContainer PJSC
- TransEnergol LLC
- Transenerkom JSC
- Transmashholding CJSC
- Transmashproekt JSC
- Transpnevmatika JSC
- Transport Equipment Plant CJSC
- TRANSWAGONMASH LLC
- TTM LLC
- TVEMA CJSC
- Tver Carriage Works (TVZ) JSC
- United Metallurgical Company JSC
- URAL ATI JSC
- Ural Car Repair Company CJSC
- Ural Locomotives LLC
- Urak Transregional Certification Centre NSEI
- Uralchem-Trans LLC
- Uralgroshakhtkomplekt CJSC
- Vagonmash LLC
- V.M. Bubnov Head Specialized Design Bureau of Car Building (GSKBV) LLC
- VNIIZHT JSC
- VNIIKP JSC
- VNIKTI JSC
- VNIIR JSC
- Voith Turbo LLC
- Volgadieselapparat JSC
- Vyksa Steel Works JSC
- Weidmüller LLC
- Yahting LLC
- Yug-Test LLC
- Zavod Metallokonstruktsy JSC
- Zheldorremmash JSC
- ZVEZDA JSC

Published by



**Institute of Natural Monopolies Research**

2/7 bldg. 1, Malaya Bronnaya Str.,  
Moscow, Russia, 123104  
Tel.: +7 495 690 1426  
Fax: +7 495 697 6111  
[vestnik@ipem.ru](mailto:vestnik@ipem.ru)  
[www.ipem.ru](http://www.ipem.ru)

Supported by



**Union of Industries of Railway Equipment**

3, Rizhskaya sq., Moscow, Russia, 107996  
Tel.: +7 499 262 2773  
Fax: +7 499 262 9540  
[opzt@opzt.ru](mailto:opzt@opzt.ru)  
[www.opzt.ru](http://www.opzt.ru)



**Committee on Railway Engineering  
of Russian Engineering Union**

The magazine is registered by the Federal Service  
on Mass Media and Cultural Heritage Protection  
Control, linense PI № FS77-31578 of 25.03.2008.

The magazine is included in the Russian Science  
Citation Index database.

To effect subscriptions for Russian-language issue is  
necessary to address to MK-Periodica JSC or one of  
its partners in your region.

Tel.: +7 495 672 7012  
Fax: +7 495 306 3757  
[info@periodicals.ru](mailto:info@periodicals.ru)  
[www.periodicals.ru](http://www.periodicals.ru)

Printed by City Print Typography LLC  
10 bldg. 41, Dokukina st., Moscow, Russia, 129226  
Circulation: 1000 copies  
Periodicity: Quarterly

Passed for printing: 25.08.2016

All rights reserved. Reproduction and transmission  
of the Railway Equipment magazine materials is  
allowed only with reference to the issue.

Not for sale.

## Editorial board

**Editor-in-Chief**

Valentin Gapanovich,  
*Senior Vice President, Chief Engineer, Russian Railways President, UIRE*

**Deputy Editor-in-Chief**

Yuri Saakyan,  
*Dr., Director General, Institute of Natural  
Monopolies Research, Vice President, UIRE*

Rushan Alyaudinov,  
*Dr., President, Ankor Bank,  
Corresponding member  
of AENPD Russia,  
Member of IIA*

David Kirzhner,  
*Dr., Deputy Head of Technical Policy  
Department, Russian Railways*

Viktor Kureichik,  
*PhD, Prof., Member of RANS,  
Chairholder, SFedU,  
Honoured Science Worker of Russia*

Nikolay Lysenko,  
*Executive Director,  
Vice President, UIRE*

Anton Zubikhin,  
*Dr., Deputy Director General,  
Sinara Transport Machines  
Vice President, UIRE*

Vladimir Matyushin,  
*Dr., Prof., Vice President, UIRE*

Anatoly Mescheryakov,  
*Vice President,  
State Secretary,  
Russian Railways*

Bulat Nigmatulin,  
*PhD, Prof.,  
Chairman of Board of Directors,  
Progress-Ecologia*

**Deputy Editor-in-Chief**

Sergey Palkin,  
*PhD, Prof., Vice President, UIRE*

Yuri Plakitkin,  
*PhD, Prof., Member of RANS,  
Deputy Director of the RAS  
Energy Research Institute*

Elmar Pozamantir,  
*PhD, Prof., Chief Researcher  
of the RAS System  
Analysis Institute*

Oleg Senkovskiy,  
*First Deputy Chief of the Technical Audit  
Center, Russian Railways*

Igor Tomberg,  
*Dr., Prof., Head of Energy and Transport  
Research Center of the RAS  
Oriental Studies Institute*

Oleg Trudov,  
*Head of division in Technical Policy  
Department, Russian Railways*

Alexander Salitsky,  
*PhD, Chief Researcher of the  
RAS Institute of World Economy  
and International Relations*

Alexander Akimov,  
*PhD, Head of Economics Research  
Department, RAS Oriental Studies Institute*

Stanislav Zhukov,  
*PhD, Head of Energy Research Center,  
RAS Institute of World Economy and  
International Relations*

## Publishing Team

**Publishing Editor:**

Sergey Belov

**Editors:**

Kevin Smith, Elizaveta Matveeva,  
Daria Kuznetsova

**Translators:**

Margarita Stupina,  
Stanislav Ershov

**Designer:**

Natalia Kozhinova





**19 | Moscow Central Ring drives development in Russian capital**



**75 | Magnetic levitation: an unknown story from Russia**



**46 | Technical and design features of the EG2Tv 'Ivolga' EMUs**

## Content

### | INDUSTRY LEADERS' VIEW | . . . . . 7

#### | MAJOR PROJECTS |

*Efim Rozenberg. Processes of Driverless Shunting Operations . . . . . 8*

*Efim Rozenberg. URRAN: new model of risk management . . . . . 14*

*Moscow Central Ring drives development in Russian capital. . . . . 19*

#### | TRENDS |

*Vladimir Savchuk, Alexander Polikarpov, Igor Skok. Russia's railway sector in 2015: the year in review . . . . . 22*

*Mikhail Mamonov. Supporting Russian engineering export. . . . . 29*

### | STATISTICS | . . . . . 32

#### | ROLLING STOCK |

*Valery Kossov. Gas-turbine locomotive on liquefied natural gas . . . . . 38*

*Evgeny Vasyukov. The world's first gas reciprocating shunter: TEM19 . . . . . 42*

*Sergey Orlov. Technical and design features of the EG2Tv 'Ivolga' EMUs. . . . . 46*

*Vladimir Dzyuban. Underground Cars Refurbishment for Budapest . . . . . 51*

### | COMPONENTS & TECHNOLOGIES |

*Georgiy Zobov. Locomotive diesel engines in Russia: current condition and prospects . . . . . 54*

*Igor Mikhalkin. Russian innovative technologies . . . . . 57*

*Vasiliy Kuryanov, Makhud Sultanov, Victor Fokin. Innovative messenger wire for an overhead contact line system . . . . . 58*

*John Worries. Amsted Rail makes everything under the railcar body . . . . . 61*

*Andrei Tiurikov. NIEFA-ENERGO aims for further development of Russian Railways . . . . . 62*

*Andrey Kamyshny, Dmitry Kerentsev, Roman Timakov. Developing and Mastering Wheels for High-Speed EMU "Lastochka" . . . . . 64*

*Alexandr Kireev, Nikolay Kozhemyaka, Sergey Sudakov. Innovative electric traction system offers major benefits for railways . . . . . 68*

#### | OPPORTUNITIES IN RUSSIA |

*Expo 1520 is waiting for foreign guests . . . . . 71*

*Nikolay Lysenko. Union of Industries of Railway Equipment (NP UIRE) in the international arena: results and prospects. . . . . 73*

#### | HISTORY |

*Georgiy Zobov, Sergey Belov. Magnetic levitation: an unknown story from Russia . . . . . 75*



## Dear colleagues!

Welcome to InnoTrans 2016!

During its more than 20 years, the bi-annual railway equipment exhibition held in Berlin has become a unique platform for industry professionals to meet, exchange experience as well as negotiate and sign contracts. InnoTrans' continuing growing popularity indicates the importance of the event.

Rail transport is a key industry in the economy of many countries.

Moreover, everyone knows that railways largely cannot exist separately from each other making individual countries partners in a single rail network. So, InnoTrans works not only for specific companies, but also contributes to the economic and social development of countries, regions and even continents.

As one of the world's most complex transport systems, which places significant demand on equipment, infrastructure and operations, railways are one of the largest customers for new developments. It is safe to say that InnoTrans is a platform which shortens the path from design to realization, and from prototype to widespread introduction.

I am sure that InnoTrans 2016 will give all participants new information, and that by exchanging views and participating in open discussions, they will help to identify solutions to some of the challenges the industry currently faces.

I sincerely wish you fruitful work, new partners and profitable contracts!

*Oleg Belozarov,  
President of Russian Railways JSC,  
Chairman of the International Union of Railways*





## Dear railway industry experts,

On behalf of the Ministry of Industry and Trade of the Russian Federation, I welcome you to InnoTrans 2016! The international exhibition, held every two years in Berlin, rightly has the title as one of the key industry events in the world. Again we will observe with great interest the technologies, reports and opinions, and experiences of implementation of infrastructure and engineering projects (especially regarding state regulation) presented during the year's event.

Despite the current political and economic difficulties, Russia is open for investment and we welcome projects aimed at deepening the cooperation between Russian and foreign companies. We are always ready for a constructive dialogue with manufacturers interested in investing in Russian industry, which will help to create jobs, transfer knowledge and develop unified design centers with prospects of entering the world market. We are ready to provide these

companies with a long-term support while offering a variety of preferential treatments.

For its part, the Ministry of Industry and Trade actively works to stimulate demand for modern railway equipment and components produced in Russia. Considerable attention is paid to innovations, which increase the efficiency of interaction between system integrators and component manufacturers. In recent years Russian exports have increased, and many of the world's largest manufacturers are using Russian-made components in their production chains.

Industrial relationships are one of the most robust and long-term forms of business relations. This is clearly evident at InnoTrans, where many exhibitors are bound together by decades of cooperation. I sincerely wish all the participants of this year's exhibition all the best in securing new successful agreements and partnerships, including with Russian manufacturers!

*With best wishes,  
Alexander Morozov,  
Deputy Minister of Industry and Trade of the  
Russian Federation*



## Dear Readers and Guests of InnoTrans 2016,

You are holding the English language version of Railway Equipment Journal, a flagship Russian technical and economic publication about railway industry issued in conjunction with InnoTrans 2016. This issue traditionally covers Russian transport engineering's latest breakthrough developments as well as analyzing the current status of the rail industry in Russia.

The role of artificial intelligence and digital technologies in the rail transport sector is increasing every year. Their deployment enhances the efficiency of rolling stock, operations, as well as the complete transportation process. Based on the experience and lessons learned during the very complex task of organizing transport for the 2014 Sochi Winter Olympics, which successfully demonstrated a record 99.6% on-time performance, Russia is now working on another ambitious project: launching Moscow's belt line railway, which will eventually become a critical element of the Russian capital's transport infrastructure. Notwithstanding the high service capacity requirements, we have achieved a high level of project automation with the driver only responsible for fulfilling the control function. Another key project now underway is focusing on deploying driverless shunting operations in Russia. This issue articles offer insight into each of these projects.

Russia and Russian Railways (RZD) are also working to improve the energy efficiency and environmental performance of its rail vehicles. For instance, Russia is home to the

world's first LNG-operated mainline and shunting locomotives which have undergone successful tests. Moreover, Russian companies are now producing new diesel engines, which are competitive with those supplied by European companies and surpass them in some parameters. You will find technical details on these recent developments in our magazine.

Another topic that is receiving increasing attention is the application of maglev technology in transport. Only a few of these systems are in commercial service today, but several projects and solutions are becoming more prominent. The most visible and talked about is a low-pressure tube train, known as Hyperloop. It is worth noting that Russian engineers contributed significantly to the development of the theoretical foundations for maglev transport in the 20th century, and completed some pilot projects to create such systems, thus providing global transport science with a rich body of experiential material. And with this tradition continuing in several projects in Russia today, we decided to present you with a chronology of maglev transport in Russia and detail the unique materials that make up this technology.

Finally, I should summarize that Russia, RZD and Russian manufacturers are ready to meet contemporary challenges and are willing to offer the world solutions that are kind to our planet's resources while improving the efficiency of transport. We are always open to constructive dialogue that will contribute to the well-being of mankind.

*Sincerely yours,  
Valentin Gapanovich  
Editor-in-Chief of Railway Equipment Journal  
President of Union of Industries of  
Railway Equipment  
Senior Vice-President, Chief Engineer  
of Russian Railways JSC*



## Export potential of the rolling stock from Russia



**Kirill Lipa,**  
CEO,  
Transmashholding

**T**ransmashholding has great potential to increase exports. In recent years, the company has made significant investments in creating and adopting new technologies, in particular to develop technical solutions and products with export potential. Our use of a modular design during the development of rolling stock allows us to create new products quickly and cost-effectively, while meeting the needs of customers and their specific operating conditions.

The international railway equipment market appears to be increasingly open, and if no barriers exist, Transmashholding participates and wins. We are currently implementing the third contract for the supply of 27 diesel trains to Serbia. This follows the successful delivery of 12 trains under the first two contracts.

Transmashholding also recently secured a contract to overhaul and modernize 222

metro cars for Budapest Metro and is supplying rolling stock for the metro in Sofia with 120 cars shipped in the past few years. In addition, in 2015 we have implemented a project to supply 15 metro cars for Baku Metro in conjunction with Alstom. This year, the company has resumed supplying diesel engines to Poland for a freight locomotive re-tractioning project.

Negotiations are also continuing for a number of projects to supply passenger rolling stock and freight locomotives in the Middle East.

The active role of the state is important to help Transmashholding become successful in foreign markets. In recent years, the Russian government has launched a number of export support programs to increase the economic competitiveness of Russian proposals for foreign tenders, and our company is a major beneficiary. 

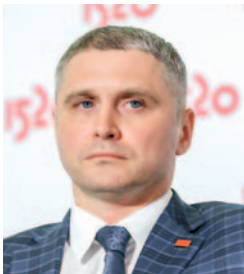

**Andrey Shlenskiy,**  
Deputy CEO  
for Railway  
Equipment,  
Uralvagonzavod

**T**he most important area of development for Uralvagonzavod (UVZ) in light of reducing domestic demand are opportunities in international markets. 2015 was an unprecedented year for us in terms of exports: every second freight wagon manufactured was shipped to buyers in foreign markets, with our main customers based in Azerbaijan, Kazakhstan and Turkmenistan. In 2016, UVZ's export efforts for its railway equipment have focused on cooperation with the Islamic Republic of Iran. A wide range of freight wagons have been designed specifically for use by Iranian companies which take into account the peculiarities of local railway infrastructure.

The success of international deals is closely linked with political agreements. At the same time, we can not rely only on foreign-policy agreements to secure international orders. To build their export potential, Russian manufacturers have to develop their own opportunities and offer potential customers integrated railway solutions which include the infrastructure and engineering elements that they require.

However, it is desirable to transfer the leading role in developing these international projects to Russian Railways. With its extensive experience and competence, RZD can lead the project while appointing Russian manufacturers and railway operators as subcontractors. 

# Processes of Driverless Shunting Operations



**Efim Rozenberg,**  
Professor, Doctor of Technical Sciences,  
First Deputy CEO of NIIAS JSC

In June 2015, Russian Railways for the first time applied driverless shunting operations (SCSnD – cab signaling for shunting operations, driverless) at station Luzhskaia, Oktyabrskaya Railroad. The shunting locomotive was operated by a station operator through a special AWS with automatic controls undertaking all functions earlier fulfilled by the locomotive crew. SCSnD function developed by the engineers of NIIAS represents an element of limited-manned operation of Luzhskaia station and is applied for the first time on Russian railway network.

## Task Description

The course towards major upgrading of industrial processes set by Russian Railways includes maximum use of scientific and technological potential accumulated by the company and related to innovative procedures oriented at new corporate model to manage the vertically-integrated business units.

The objective targeted was to move from automation of scattered operations to the establishment of a complex system, i.e. integrated technology platform capable to consolidate all available sources of data related to status of controlled elements and operations into a corporate infrastructure cluster. Such new platform – Intelligent Rail Transport Control System (IRTCS) – ensures fast access of control architecture and application systems to necessary information all over the railway network.

Such policy is primarily associated with the intellectualization of railway safety systems and development of railway infrastructure

oriented towards proper evaluation of assets reliability, as well as reliable projection of its change. The solution of this objective through the automation of decision making processes would minimize human element in control systems performance.

The operation of data management and control systems is based on the automatic capture of data on controlled process and object parameters, as well as transmission of commands to those objects that may include locomotive systems and office-based route control complexes.

In order to achieve these objectives, rail automatic control and telecommunication systems require improvement, including creation of infrastructure facilities digital models, deployment of digital telecommunication network, upgrading of spacing control systems, as well as equipment condition monitoring and automation of some industrial operations (see Figure 1).

## Innovative Marshaling Yard Project

A key element of the structure that ensures automatic monitoring of processes at yards was tested at Yaroslavl station where innovative solutions have been used: artificial vision for locomotive uncoupling (attaching) monitoring, satellite positioning, visual recognition of

car identification numbers and detection of employees getting into dangerous areas. The real achievements in train splitting (recoupling) automatic control were however demonstrated at Luzhskaia station marshaling facilities and were based on the integration of microprocessor



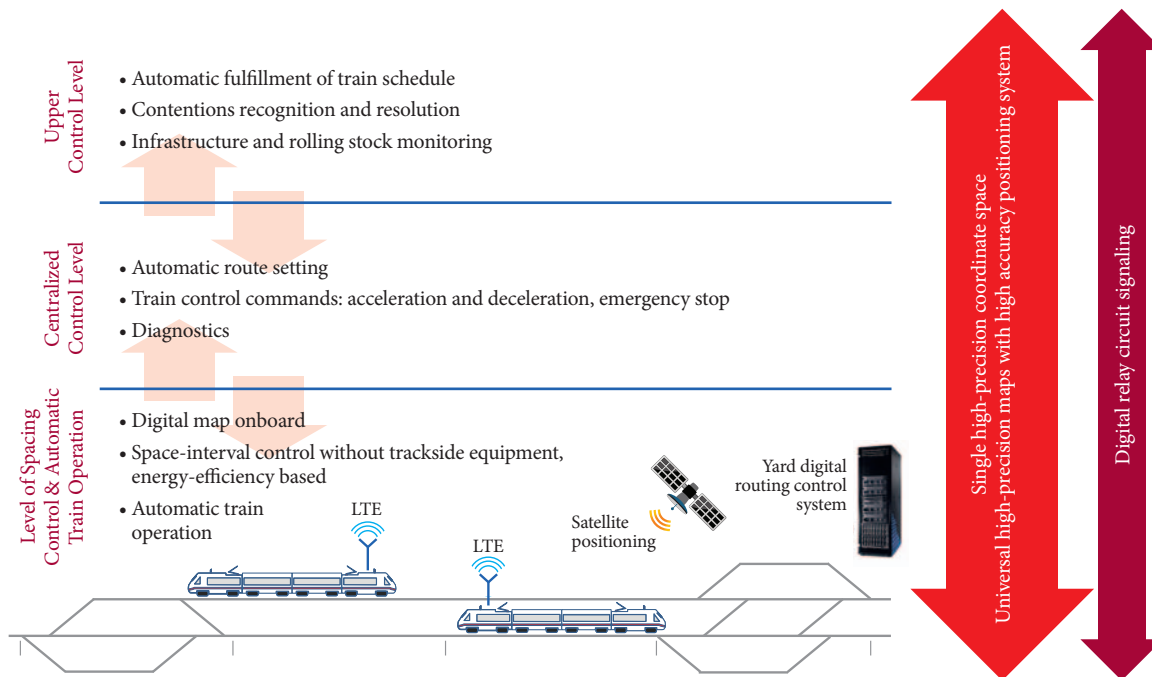

Fig. 1. Digital Integrated Train Control System

interlocking system ETs-EM by Radioavionika, microprocessor automatic controls for marshaling yards MSR 32 by Siemens AG, automatic cab signaling for shunting operations SCS by NIIAS, and automatic hump locomotive operation SAU GL by VNIKTI.

The first system has been extensively deployed throughout Russian Railways network. As for MSR 32 system, it was its first implementation in Russia. In its turn, SCS system is being rolled out since 2012 (see Figure 2), but was extended with driverless locomotive operation function in case of Luzhskaia trial. SAU GL is responsible for meeting the locomotive speed limits assigned by onboard SCS equipment or MSR 32 depending on the concerned operation.

The SCS system is built on the basis of digital satellite positioning map, digital telecommunication, and secure computing yard and locomotive complexes. The system is unrivalled elsewhere in the world due to its functional capabilities and has interfaces both with relay interlocking and state-of-the-art microprocessor interlocking by Radioavionika JSC and Bombardier Transportation (Signal). The following operations are fulfilled in driverless mode: locomotive driving to consist, coupling to consist, and coupling control. The two latter operations required equipping of automatic hump locomotive operation system

with special devices – distance meters and level meters – in order to record hitching to cars. All yard shunting operations are performed in driver operation mode under SCS supervision. The application of the SCS allows reducing human element effect on train operational safety. The analysis of statistic returns from locomotive operation shows that in the most cases that required the system interference in operation, sometimes to the extent of enforced braking, driver tried to override manually the permitted speed limit that previously remained unnoticed unless caused an accident. All speed limit violation events committed by the locomotives operating under SCS system are recorded in log reports and transmitted to diagnostic AWSs, including those situated in locomotive depots.

Visualization of locomotive motion parameters and driver acts, package of locomotive operation commands available in yard operator's AWS, and information about routes and light signals displayed on locomotive SCSs create conditions for safe operation cross checking by station personnel and locomotive crew and ensure process transparency. The current traffic status including switch engines positioning and information of work performed over particular time period are reflected on data displays available at shunting operator

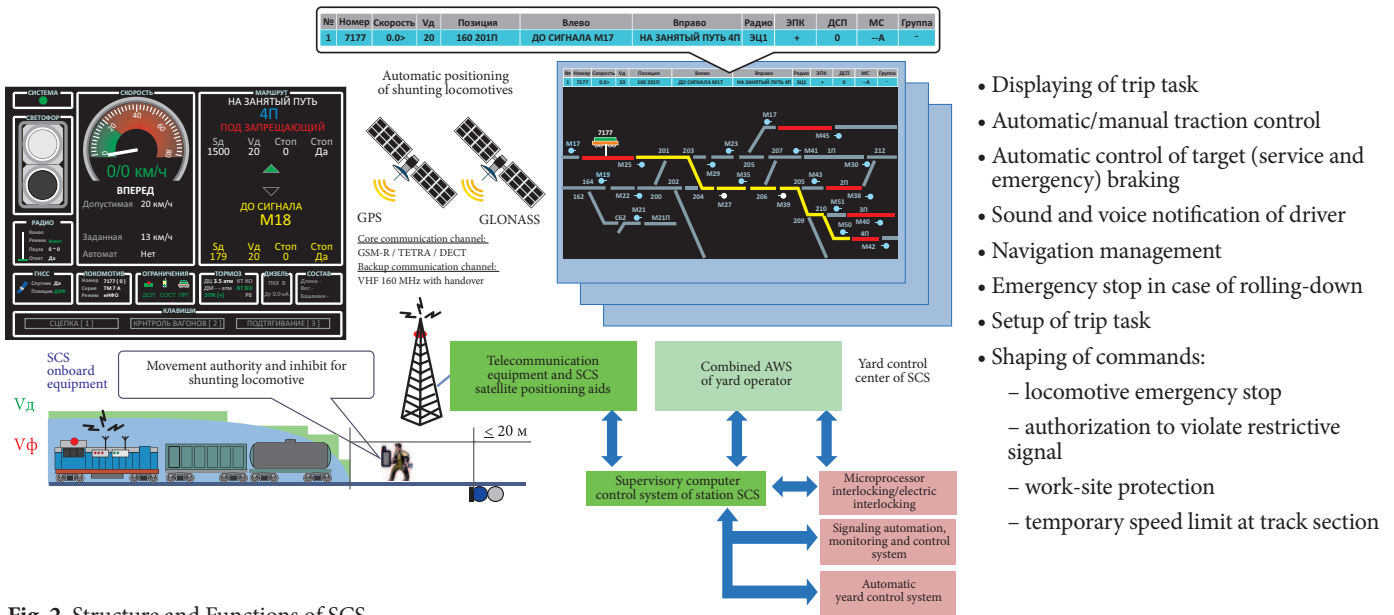

Fig. 2. Structure and Functions of SCS

and station manager AWSs and in process log reports. This information allows timely optimization of shunting operations routine planning, reduction of interoperation intervals, and reviewing of performance of the system and the station in prior periods.

MSR 32system is responsible for consists humping and splitting, rolling-down and car gripping on marshaling tracks. The combination of German technology and local infrastructure and rolling stock required serious efforts. The design of Luzhskaia station was developed in collaboration with Siemens AG. The functions and parameters of available equipment were mostly at typical domestic yard level. However, the pilot had its significant differences. The European envelope is smaller and axle load parameters are lower than the local ones. Moreover, Siemens technologies are in line with the most recent achievements of yard operation management techniques available in Western Europe. This is precisely why they impose strict requirements to the facility design. Both gravity hump and classification tracks shall meet design elevations and gradients, as well as staging yards plans and profiles. Meeting of all those requirements became possible due to the greenfield approach chosen for the construction of the yard.

A number of innovative solutions were introduced for the first time during the Luzhskaia pilot. The solutions were aimed at the implementation of unmanned processes enhancing labor efficiency and mitigating human

factor affecting process performances. In addition to the unmanned operations outlined above, it is worth noting consists automatic gripping in a receiving yard. It is provided with use of point hydraulic retarders and allows to reduce need in flagman teams (four persons each). The solution could also result in the reduction of 1-2 hump engine teams at those locomotives that operate in driverless mode. Any comparison of technical and economic performances of Luzhskaia station sorting system with the best European and Russian references would be reasonable as soon as the station reaches its planned capacity. However, it is evident even at this stage that the station process automation level makes it more advanced.

In general, the automatic control representing the lower layer of information management systems should be viewed as three intrinsically related control levels. The upper level is responsible for control commands generation by the IRTCS (rail intelligent control system) for optimal fulfillment of train schedules with due consideration to contentions solving.

The middle level ensures bringing technology decisions to routing in stations, transmission of information about changes in time schedule to locomotives and obtaining of information about operating parameters and positioning of all vehicles. The same functions are supported by onboard infrastructure diagnostics devices.

The lower and most critical level is represented by safety systems that ensure train spacing control and remote wayside control



at stations. All three levels are represented by hardware and software complexes with special focus on safe railway operation.

The key element ensuring efficient management of infrastructure automatic control and monitoring systems, and train safe operation are digital maps. The maps together with digital telecommunication, and security computer aids used both on-site and in rolling stock, allow reaching full-scale automation of some process operations providing not only reliable records in IRTCS but also automatic implementation of control commands in the course of traffic management.

Yard automatic control complexes are the most sophisticated and critical automation systems which performance is critical for IRTCS systems efficiency. The functions of marshaling yard automatic control systems used in Luzhskaia pilot project are described at Figure 3 below. Extended capabilities of automatic control systems makes it possible not only to use conventional control techniques but at the same time to enhance labor efficiency through addressing fundamentally new objectives – overall automation of rolling stock diagnostics systems, use of e-document flow with digital signature in communicational exchange with information management systems, and automatic control of rolling stock gripping process and switch engine operation. The bunch of the above aids allowed introduction

of automatic splitting of second category hazardous freights.

It is impossible to use an automatic control system for the operation of any key asset without relevant protection of critical information structure in its entirety. This need is easily explained by large-scale deployment of wide range IT solutions into control systems applied for industrial and technical processes, globalization of current information and telecommunication networks, their transformation into shared international information and telecommunication network. This is particularly critical for microprocessor-based train operation control systems (computer-based and centralized traffic control, locomotive safety systems, etc.).

It is obvious that the priority shall be given to domestic microprocessor-based systems with open source code both in case of newly built projects and in case of assets upgrading.

To address the objective of analysis and implementation of cyber protection features during the development and introduction of information systems, Russian Railways initiated the establishment of the Cyber Security Center on the basis of NIIAS. All hardware and software created today shall undergo a comprehensive cyber sensitivity check. The protection of complete local railway network is today the key requirement meaning the engagement of all company divisions into establishment of fully comprehensive protective structure playing

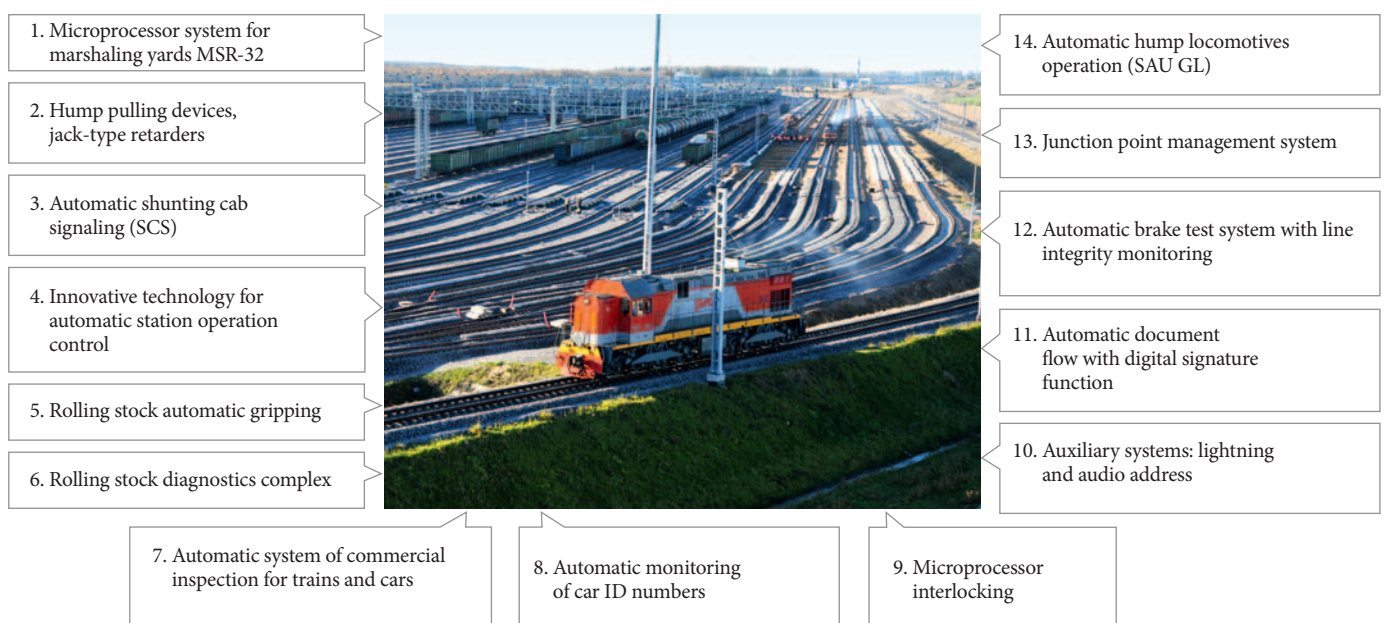

Fig. 3. Sorting infrastructure of Luzhskaia Station. Modular architecture of yard control system

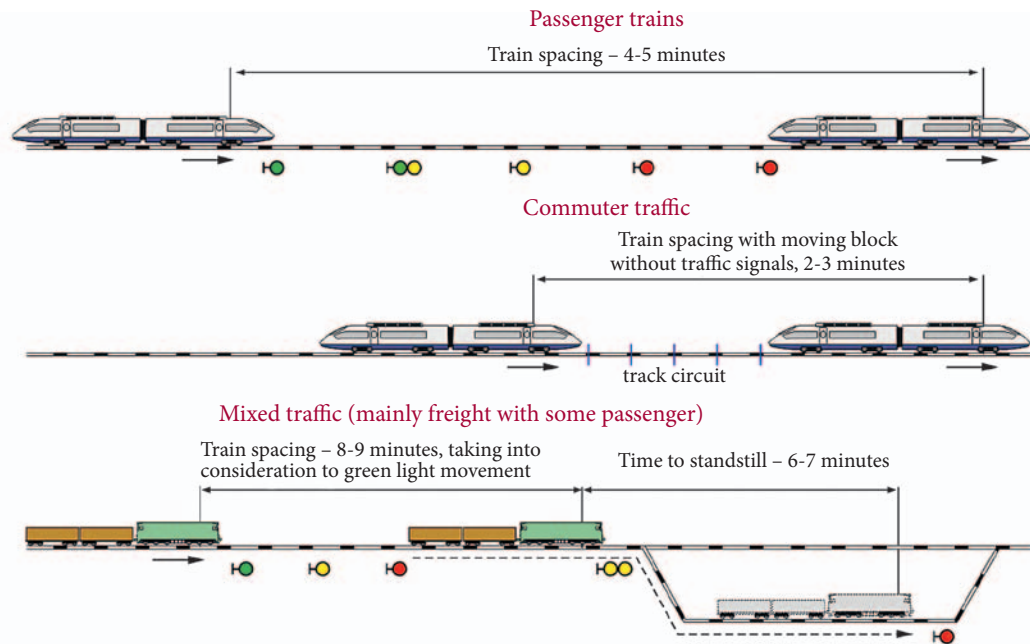

Fig. 4. Passenger & Freight Trains Spacing

critical role in the context of current shared IT environment. Moreover, under special industry standard STO 02.049-2014, cyber protection shall be an element of all innovative solutions integrating microprocessor technologies. The approaches to cyber protection stipulated in the above statutory document have been approved by the representatives of allied Russian industries like nuclear, power sectors, etc., and widely accepted among international decision makers from Austria, Switzerland, Italy and Germany.

The evolution of domestic train operation solutions allowed change-over to train space-interval control that uses traffic-lights free signalling. It utilizes audio frequency track

circuits in conjunction with moving blocks. Unlike the traditional model, the new process allows setting of random length block intervals, thus increasing significantly train traffic density. In case of traditional interlocking, a track section is divided into blocks generally having standard length, ensuring safe braking in case next section is occupied. However, the same line may be simultaneously used by full-length freight trains, passenger trains and suburban multiple units. All them have different length and speed and therefore different braking distances. Therefore, some trains require a block of few kilometers, and another ones – only few hundred meters. And all this traffic diversity shall meet the same traffic safety requirements.

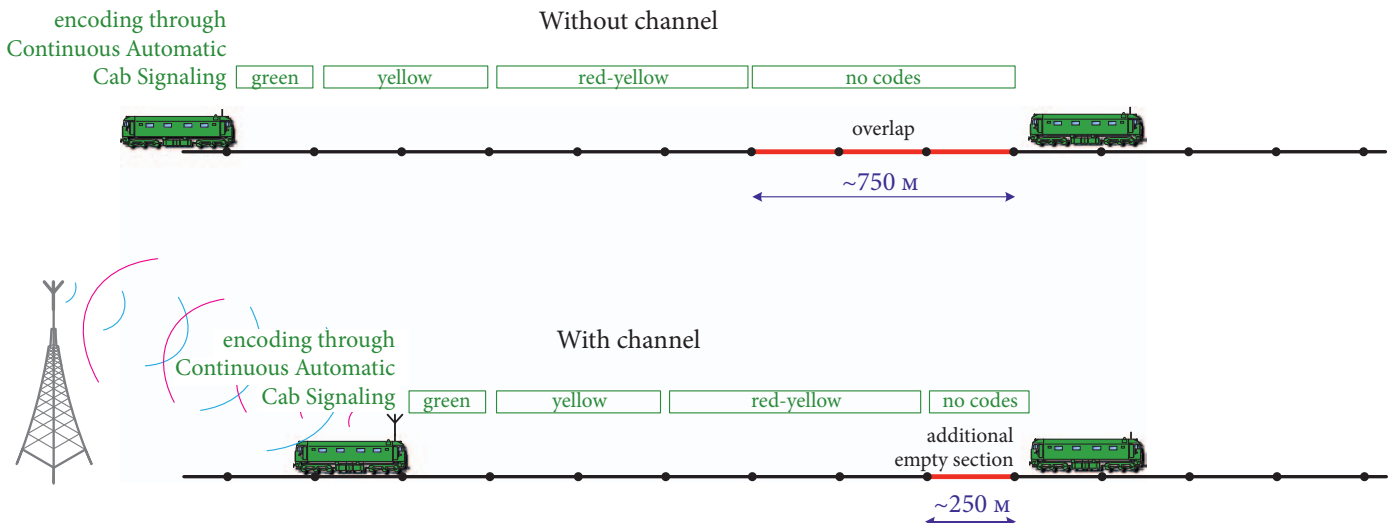

Fig. 5. Reduction of vacant (clear) section length in case of additional communication link with train

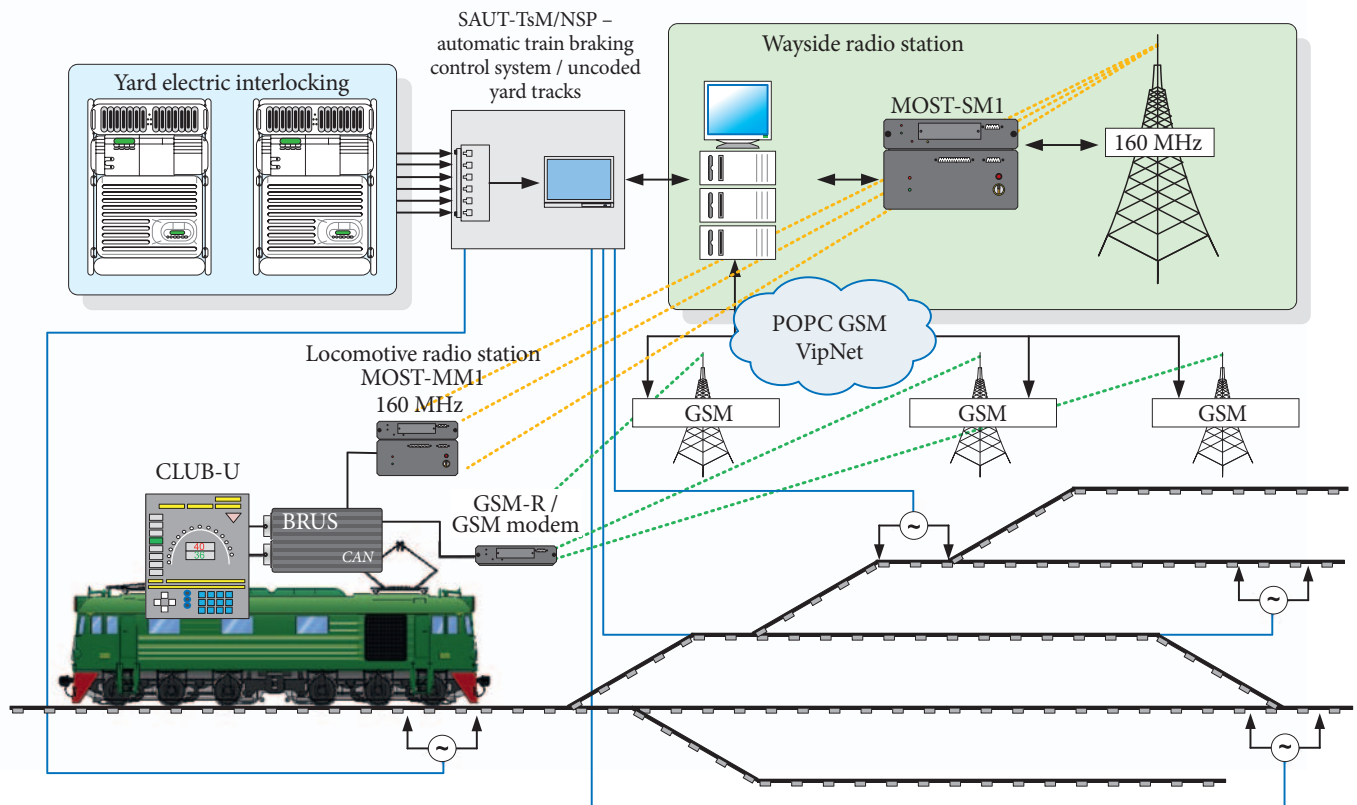

Fig. 6. Information radiobroadcasting for yard tracks coding

The solution has been already implemented in practice in form of microprocessor-based block signaling with audio frequency track circuits developed by NIIAS under the assignment of Russian Railways. Such system is used today as the core of lower layer of automatic control systems on the Moscow Ring Railway (see Figure 4).

The system is already launched in full-time service at one section of Moscow Railway (Ordzhonikidzgrad – Sel'tso). Due to its multifunctional nature, it may simultaneously control traffic lights, monitor subsequent holding and emptying of track circuits and perform their coding. Moreover, the system allows control and monitoring of automatic crossing signalling, automatic and manual overriding and clearing of stop aspects of intermediate signals, as well as change of trains movement direction in station-to-station blocks. Under dense traffic conditions on the Moscow Ring Railway with nearly 100 train-pairs of EMUs per day with rush-hour headway of 5 minutes, other features of the innovative solutions implemented today will be of particular value.

In order to reduce significantly capex requirements, functional capabilities of spacing

control signaling was expanded utilizing radio channel communication (see Figures 5-6). Such solution allows reduced length of additional empty blocks and makes it possible for trains to run through station side tracks due to radio channel based locomotive communication. The solution is currently implemented at Moscow-Nizhni Novgorod sections that require increase of trains speed while keeping unchanged blocks length and arrangement of traffic signals.

The implementation of all engineering solutions described above requires state-of-the-art locomotive safety systems. The most advance BLOCK system (integrated train operation safety system) introduced en masse since 2013, comprises functions of several safety systems, utilizes satellite positioning and may obtain information both from track circuits and digital broadcasting channel. The system has proved very effective when it was introduced for the first time in Sochi-2014 operating domain. And today it is installed on newly built locomotives.

Generally speaking, lower level automation is essential for IRTCS performance enhancement, especially when it comes to the improvement of information reliability and labor efficiency on railway networks. 🚂



## URRAN: new model of risk management



**Efim Rozenberg,**  
Professor, Doctor of Technical Sciences,  
First Deputy CEO of NIIAS JSC

Specific approaches for assurance of reliability and safety of technical devices operation at railway transport were developed in the structure of Russian Railways. URRAN<sup>1</sup> project serves for such target at stages of the life cycle of railway transport facilities. This is a system that supports management decisions for ensuring the safety and reliability requirements in order to reduce operating and capital costs.

Russian Railways has started to develop and implement a new set of standards designed to ensure the reliability of technical means six years ago. It was necessary to create standards, methodologies and guidelines being used for managing the processes of life cycle of railway transport systems. For this purpose, the harmonization of the own normative basis for infrastructure management with RAMS standards<sup>2</sup> system (widely used at the European Union's and the United States' railways) has been started.

RAMS methodology while ensuring the safety and reliability at all stages of the railway transport object's life cycle is based on the ALARP principle<sup>3</sup>. The essence of it is to provide such a low level of residual risk as far as reasonably possible, including based on economic considerations. However, it does not fully solve the problems of reliability, safety and resources management and does not cover aspects of durability provided by Russian standards. In addition, RAMS almost does not consider the human factor and does not deal with the problems of management of costs for maintenance and modernization of infrastructure facilities at the life cycle stages. This has required to transform the RAMS methodology approaches into URRAN system (Figure 1).

The purpose of URRAN system is to achieve such a state of railway transport, at which the risks of harm to people and

environment, economic losses, damage to infrastructure and rolling stock are reduced to an acceptable level. Just reduced, but not eliminated, because it is impossible to eliminate the risk completely.

The system of operating indicators of reliability, availability, maintainability, functional safety and durability of railway infrastructure facilities and railway rolling stock is based on the RAMS European methodology taking into account the amounts of work performed by railway engineering facilities of various kinds.

In contrast to the systems used in Europe, in the URRAN system the risk management was brought to the stage of determining the specific qualitative or quantitative indicators of the life cycle for each type of object or process. Scientifically-reasoned criteria of the technical condition of the equipment for extension of fixed service life of technical equipment were developed for the first time.

Approaches adopted in URRAN allow, during the planning of the works, to justify the need for a major overhaul or an extension of the infrastructure facilities service life on the basis of economic criteria (costs for current maintenance, scheduled and unscheduled repairs, condition assessment and forecast for the future) in strict compliance with the safety standards for the transportation process. Assessment of the infrastructure's status and operation in URRAN system is carried out

<sup>1</sup> Abbreviation in Russian for resource management, risk management and reliability management

<sup>2</sup> RAMS (Reliability, Availability, Maintainability, Safety)

<sup>3</sup> ALARP (as low as reasonably practicable)

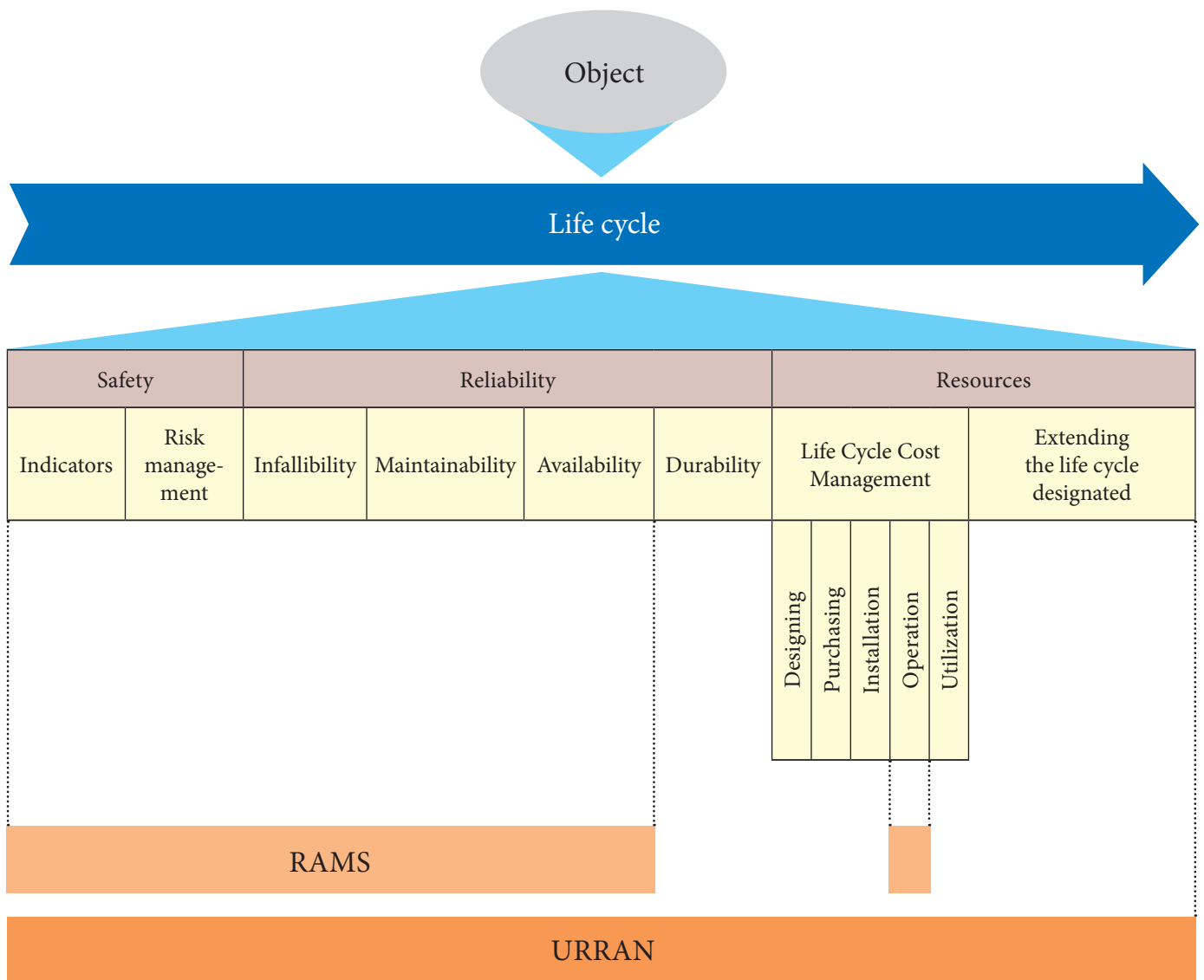

Fig. 1. Decision Support System. Transformation of RAMS methodology into URRAN system

according to integrated indicators. One of these indicators is idle factor which takes into account the impact from the infrastructure status onto the train delays.

Set of normative and methodical documents was developed within URRAN national standards, Russian Railways standards and techniques. The use of these documents in practice of infrastructure servicing was first tested at the proving ground of track facilities of the Northern Railway, and now it is replicated at the entire railway network. New methods for determining the risks and practical advices on the technical condition assessment have allowed railway-workers to save significant funds being allocated for current maintenance of the track facilities.

Also, methods have been developed for assessment of fire risks at railway stations, data-processing centers, stations of electric centralization, centralized traffic control, automatic switching, diesel and electric locomotives.

The audit and risk calculation were completed at 357 railway stations of the Directorate of railway stations (entire network), the fire audit at 32 stations of electric centralization of the 2nd class (at 16 railway roads), the fire audit of risk calculation at 16 data-processing centers, of 5 types of diesel locomotives and 3 types of electric locomotives (13 series of traction units in total). Saving is several hundred million rubles.

It should be taken into consideration that in such complex systems as rail transport the manifestation of the most undesirable events is not limited to any one type of risk. The same events can lead to any combination of individual, social, environmental, technical and economic risks. So, by train crash can be affected: the staff (individual risk), the surrounding population (social risk), the rolling stock and infrastructure (technical risk), the property of the company and the third parties (economic risk). Also an environmental pollution and inflammation of forests can occur (environmental risk).

When implementing the risk management system, the identification of all possible hazards (usually using the expert techniques) is carried out during the initial stage. Then the list of risks is formed and their acceptable levels are set on the basis of existing regulations or statistics on the frequency of hazardous events and the damage caused by them during the preceding period. It is also possible to use the expert methods here.

Implementation of two conditions – the possibility of manifestation of an unwanted event and the susceptibility of the object to its influence – is a sufficient basis for recognition that the risk exists. At the same time it is evaluated as a combination of the probability of an unwanted event occurrence and the possible consequences.

Uncontrolled risks can lead to unplanned operating costs, harm to people, environment, property and other negative consequences. The risk management process provides identification of the hazards, determination of the frequency and the consequences of events, risk assessment, its treatment and monitoring.

The following methods are used to determine the frequency of event occurrence at the railway transport:

- assessment of the frequency of occurrence of certain event in the past on the basis of statistical data (data collected over a period of operation of the infrastructure object or rolling stock under consideration and contained in the automatic control system of branch equipment or AS BR<sup>4</sup>), prediction

of the frequency for the event occurrence in the future;

- assessment of the frequency of occurrence of certain event based on the data about the failures of technical equipment (data contained in KASANT system<sup>5</sup>) that occurred during a certain period of time and that are due per unit of measurement of operational work for each equipment of rail transport;
- forecasting the event frequencies using the analysis of a chart of possible failures of infrastructure object or rolling stock ("fault tree» analysis – FTA) and the analysis of a chart of possible consequences from a particular failure ("event tree" analysis – ETA);
- assessment based on the indicators of operational reliability and operation safety for railway infrastructure and rolling stock for passenger and freight transportation with speeds of up to 160 km/h and for high-speed running;
- assessment based on expert opinion. When carrying out the expert evaluations take into account any available information about the object of infrastructure or rolling stock: statistical, experimental, constructive and others.

According to the requirements of GOST R 54505-2011, the risk analysis allows to identify the sequence of events that lead to certain consequences (outcomes) and to calculate the probability of each outcome. Below see an example of plotting an event tree (Figure 2) taking into account the protective measures used on a pedestrian crossing of the third category. During calculation of event probabilities it is assumed that, according to experts' data, 5% of pedestrians do not assess the danger from approaching train, 10% of pedestrians wrongly assess the danger (think that have enough time to pass the rails before the approaching train, etc.).

On the basis of risk model adopted, you can calculate the probability of pedestrian's injuries at the single-level crosswalk for given railway stations.

Effect analysis provides an assessment of the results from undesirable event onto people, property and environment on the

<sup>4</sup>AS BR - automated traffic safety control system

<sup>5</sup>KASANT - complex automated system for accounting, control over elimination of technical equipment failures; it was introduced in 2007



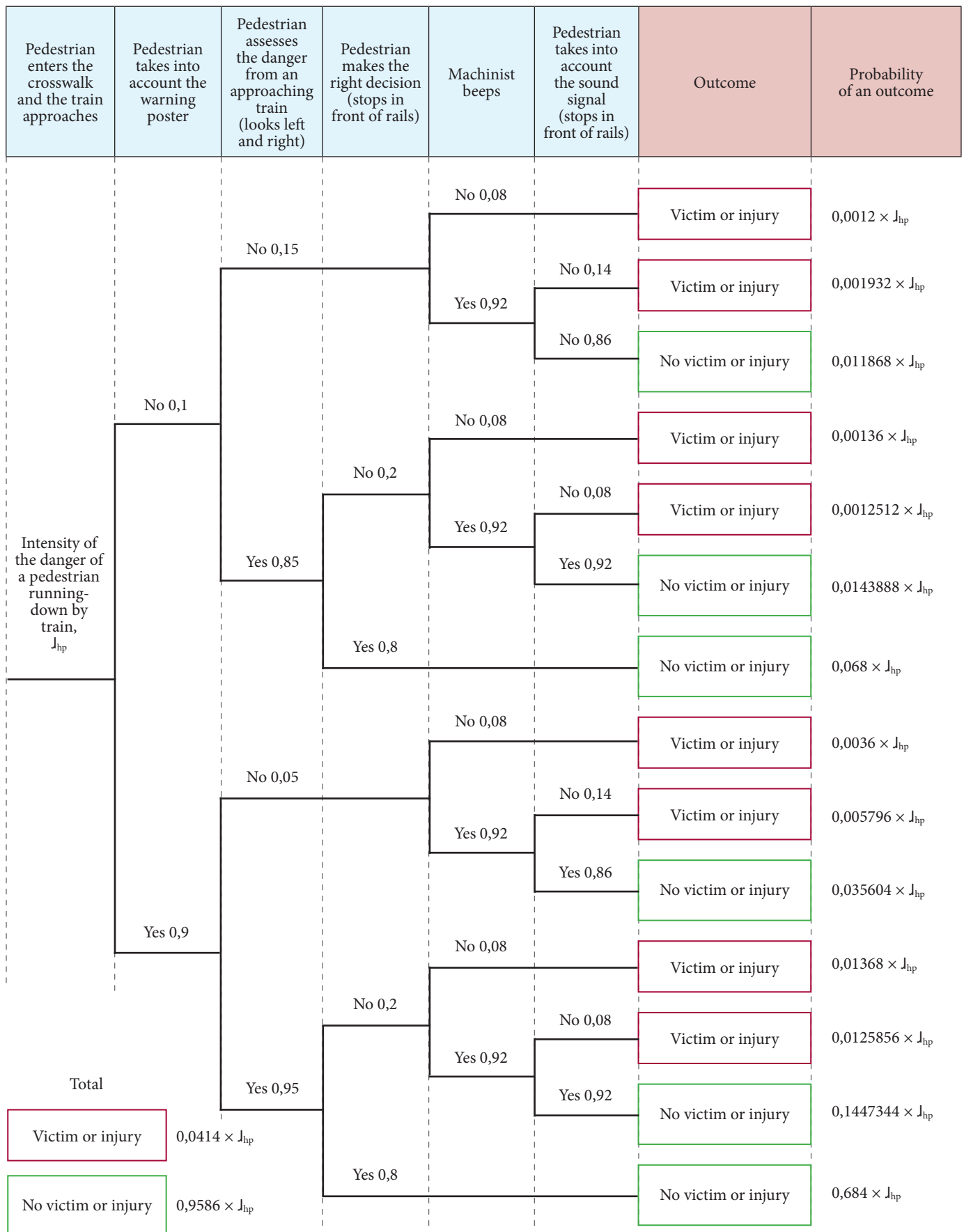

Fig. 2. An example of an event tree for assessing the risk of pedestrians' injury at the crosswalk of the third category

basis of statistical data about dangerous events for the objects of infrastructure and rolling stock being derived from automated systems. Integrated automated subsystem for accounting and analysis of cases of technological failures (KASAT), KASANT and the AS BR calculate the assessments of the relevant risks. These data allow a manager to adopt a responsible decision on the risk treatment based on its importance and to determine the order of financing and implementation of necessary risk treatment measures.

When comparing the risks associated with various undesirable events, developing the rational protective measures, calculating the damage avoided as a result of the measures and assessing the cost-effectiveness of risk minimization measures, all components of the damage should be assessed in the same units – in terms of value (in form of damages, losses).

In practice, the following variants of measures for risk treatment are widely used: prevention, transfer, reduction and adoption of risk. From the viewpoint of the risk minimizing, the first three variants are of interest. The main and most useful (for infrastructure objects) risk treatment method is its reduction. At the same time, the implementation of means for monitoring the dangerous failures and other undesirable events allows to reduce frequency of their occurrence or extent of the possible consequences, thus minimizing the risk being monitored.

For example, the consequences from failure of the train braking system may lead to numerous victims, infliction of significant damage to environment and property. It is almost impossible to reduce the extent of consequences from such dangerous failure. But the use of means of technical control over the state of brakes, automatic devices will allow to reduce significantly the frequency of hazard occurrence, so that the risk is minimized.

Risks associated with infrastructure objects (facilities) are determined by the components being added at various stages of the objects' life cycle. For example, the risk of violation of traffic safety due to the failure of technical equipment of railway automatics and telemechanics (RAT) depends on three

main components of the equipment failures intensity: permissible, designed and actual. Allowable failure intensity is fixed by requirements for the transportation process (while ensuring traffic safety), design failure intensity characterizes the system during the creation at such stages of life cycle as development, designing and production, and actual failure intensity corresponds to indicators of failures during operation of RAT object.

The risk management process is in close connection with the management of costs for infrastructure maintenance. Extension of the service life of complex technical systems is determined by results of instrumental diagnostics of the object's actual state. The final decision on the service life extension is made based on the analysis of dependence of the technical system reliability indicator from the operation time or work done (expressed in physical units).

Thus, decision support system established within the URRAN project for risk management will allow to provide acceptable levels of risks and optimize operational costs, but also to allocate rationally the investments into infrastructure objects.

The decisions of the Expert Council of the International Union of Railways contain recommendations for harmonization of national and international standards to ensure the safety of rail transport operation.

Within the URRAN project, the company has carried out extensive work on the analysis of the requirements of international (ISO 31000:2009, IEC/ISO 31010:2009, EN 50126, etc.) and state (GOST R 51897-2011, GOST R 51901.1-2002, etc.) standards in the area of risk management and the determination of their applicability to the Russian railway transport. As a result, corporate standards aimed onto implementation of the risk management system in "Russian Railways" have been developed. These standards fix a complex of requirements and approaches that allow to implement a fully-functional and efficient risk management system. They are harmonized with international and European standards in the field of functional safety and risk management, consistent with existing standards in the field of railway transport. 

## Moscow Central Ring drives development in Russian capital

Passenger services on Moscow's Central Ring (previously the Small Ring of Moscow Railway) will commence in autumn 2016. Russian Railways (RZD), in cooperation with the Government of Moscow, has been implementing this project since 2011. It promises to improve public transport and at the same time create opportunities for new business development along the perimeter of the Russian capital.

### Meeting the challenges of modern times



Fig. 1. Station of ring road, north of the city in Vladykino, beginning of XX century

The decision to construct the Moscow Circular Railway (MOZhD, formerly known as MTsK) was adopted in autumn 1897 according to an initiative of the minister of finance of the Russian Empire, Sergei Witte by the order of the last Russian Tsar Nicholas II. The designer of the project was the railway engineer Peter Roshevskiy and the prerequisite for its construction was that in the late 19th century Moscow had become a major railway network bottleneck.

Construction of the project took five years to complete and the line entered service on July 19 1908 (Fig. 1). Passenger and freight traffic started simultaneously, solving the bottleneck problem in a short period of time. For its time, the Small ring was an outstanding engineering achievement. Following the completion of construction, copies of the drawings were requested from Nicholas II after by the British government which wanted to build a western circular railway in London. These engineering drawings are still held at the British Library in London.

Electrification of the ring line was hindered by low old bridges over the tracks, which effectively excluded MOZhD from urban electrification projects in Moscow during the 1950s. As a result, the ring was used exclusively by diesel freight traffic serving Moscow's industrial enterprises, the Moscow Railway's nine lines and the Oktyabrskaya Railway as well as industrial areas in other parts of the city.

Prior to the full-scale reconstruction of the bridges in 2013, an average of 30-35 pairs of trains per day used the line with an average of 70 pairs of trains transferring between the ring and the connecting lines. Approximately 90,000 wagons were unloaded along the small ring during the year, the share of the construction materials cargo was two-thirds of the total unloading volume.

Over time, Moscow's development priorities have changed: the offices of many corporations and government agencies as well as industrial zones are now increasingly located outside of the city. This poses serious



challenges to redistributing passenger traffic to suit the needs of those residing in the city center.

According to Rosstat's data for 2016, Moscow's population has increased by

1.4 million people in the last 10 years to now exceed 12.3 million people. This creates a serious problem for the city's public transport system, which is increasingly unable to cope with demand.

## Investing in the future

The total investment in the MCR reconstruction project up to June 2015 amounted more than €3bn including €1bn investments by Russian Railways, €144m from the Government of Moscow, €367m from the Moscow Circular Railway, and €1.4bn from a group of investor companies.

The length of the ring is 54km, or 145km if taking into account the adjacent branches and feeder tracks. The small ring connects with 22 branch lines and passenger traffic using the revitalized MCR will use two tracks, with a new 31km third track reserved for freight traffic. The improved line will have 12 operating freight terminals and 31 passenger stations.

The newly developed line is also expected to stimulate economic growth due to the improvements it will offer to Moscow's infrastructure. It is expected to create over 10,000 jobs, including around 4,000 that will be engaged directly in passenger transport.

According to the updated General Plan of Moscow Railway Node Development, the new trains on the MCR will serve up to 75 million passengers in the first year and 120 million by 2020. With the developments expected adjacent to the line, and additional transport interchange facilities, this could rise to 300 million by 2025, which is comparable with current traffic levels on Moscow Metro branch lines.

## Innovative approach

When passenger traffic on the MCR begins this autumn it will open up a number of new ways to navigate the city. With the opening of the each planned station in the next few years, passenger will be able to plan more convenient and comfortable journeys. Indeed 16 stops on the new line will connect with 17 Moscow Metro stations while nine stations will connect with suburban network stations (Fig. 2).

The MCR stations have been designed with maximum passenger convenience in mind. A system of covered walkways and galleries will protect pedestrians from the rain, cold and other adverse weather conditions. Some stations, including Kutuzovo, City, Shelepiha and Luzhniki will be equipped with a glass roofs to allow to use natural light to illuminate the concourses (Fig. 3).

To further enhance passenger convenience, an integrated ticketing system is planned for the MCR which is similar to the existing system used on the metro, buses, trolleybuses and trams.



Fig. 2. Plan of Small Ring of Moscow Railway



Fig. 3. Sketches of transport hubs: a) Kutuzovo; b) Luzhniki; c) Botanicheskiy Sad

The MCR will operate reach 110 pairs of trains a day at 6 minute intervals during peak times and 11-15 minutes during the off-peak. The complete full circular journey will take 1h 30min, and trains will operate daily from 05:30 to 00:30.

Lastochka EMUs (ES2G, Fig. 4), which have been built at Ural Locomotives factory in Verkhnyaya Pyshma, Sverdlovsk, will be deployed on the route. The five-car 160km/h trains are 130m-long and are based on the prototype DesiroRus built by Siemens, which first served the guests and participants of the 2014 Winter Olympic Games in Sochi. The trains can be extended to 10 cars and have been adapted to Russian conditions; they feature a wide body created specifically for Russia's generous loading gauge, and offer ample interior space. This is aided by the location of train equipment under the floor and on the roof of the train.

High density operations on the line will be achieved through the use of innovative interval regulation system, deployed by RZD and developed by NIIAS. This train control system uses a microprocessor to offer automatic block system and is based on GPS/GLONASS and GSM-R standard communication technologies which track the location and speed of Lastochka trains, control the distance between each set and adjust the train diagram in online mode. This innovative control system, which eliminates traffic lights, will greatly reduce headways



Fig. 4. Electric trains "Lastochka" for the Moscow central ring

while guaranteeing safety and increased comfort for passengers.

The automatic train control system will initially support driver operation. However, in the future it will permit fully automated operation where a person is only required in a control capacity. In the event of an abnormal situation, the system will alert the dispatcher and automatically transmit over GSM-R the new train diagram to drivers. This system was operated successfully during the Olympic Games in Sochi in 2014 where Lastochka trains transported 4.8 million passengers, including up to 311,000 passengers during the peak, with trains operating at a 99.6% punctuality rate. (S)

## Russia's railway sector in 2015: the year in review

**Vladimir Savchuk,**

Head of the Railway Transport Research Department, Institute of Natural Monopolies Research (IPEM)

**Alexander Polikarpov,**

Deputy Head of the Railway Transport Research Department, IPEM

**Igor Skok,**

Senior Expert and Analyst in the Railway Transport Research Department, IPEM

Rail transport is a critical element of Russia's economy. It supports the delivery of raw materials and finished products, military equipment and socially-important freight, and provides transport for passengers in almost all regions of the country. Often, it is the only mode of transport available for moving freight and people. Inevitably the task of restoring economic growth in Russian is demanding greater efficiency and reliability from its railway network as well as high availability and quality of rolling stock.

### Passenger transportation and rolling stock

In 2015, total passenger traffic in Russia for all modes of transport was 466 billion passenger-km, with rail transport accounting for 25.9%. Rail transported 1.02 billion people, about 90% of which is attributed to suburban transport services which cover distances of up to 200km.

Suburban services primarily use electrical multiple units (EMUs) produced at Riga carriage works in the 1970s and 1980s, as well as modern Russian EMUs produced by Transmashholding (TMH) at its Demikhovsk engineering plant. In addition, several high-speed EMUs have been introduced on the network. Since 2009, Velarus Rus high-speed EMUs supplied by Siemens have operated between Moscow and St Petersburg, while services between St Petersburg and Helsinki have been operated using Alstom Allegro EMUs since 2010. These trains are a member of the French manufacturer's Pendolino family of tilting trains.

Passengers are also benefitting from the deployment of ES2G «Lastochka» (Swallow) EMUs, which are based on Siemens' Desiro platform, and have been produced in Russia at Sinar's Ural Locomotive plant since 2014. These trains are gradually being introduced on services across the Russian Federation, and are an increasingly important part of the 12,000 car fleet.

Long-distance services account for the remaining 10% of all passenger rail services in

Russia. 98% of passengers using these services travel in second-class and compartment coaches with conventional seating accounting for less than 1% of all journeys. This is due to the considerable distances that these trains cover, with the 9,423km journey between Moscow and Vladivostok the longest on the network, which takes six days non-stop.

The rolling stock used for these long-distance services almost entirely consist of coaches manufactured at TMH's Tver Carriage Works (TVZ). The plant also produces double-deck coaches, which have been in operation since 2013 on Russia's busiest long-distance rail corridors, and RIC-class coaches for international services through an agreement with Siemens.

An exception to this is the high-speed train «Strizh» (Swift) which operates the Moscow – Nizhny Novgorod service, as well as on a number of international routes. This train utilizes 140 high-comfort coaches produced by the Spanish company Talgo under a €135m contract. In total Russia's *fleet of passenger coaches* (which rely on locomotive traction) consists of more than 22,000 vehicles, with nearly 70% considered to be reaching the end of their service life.

*Russia's passenger locomotive fleet* is made up of Czechoslovakian-built AC and DC electric locomotives operated since the Soviet era, diesel units manufactured at TMH's Kolomna plant, and domestically-built electric



**Table 1.** Technical characteristics of passenger locomotives manufactured in Russia

Designation	Company	Locomotive type	Power [kW]	Speed [km/h]	Weight [t]	Axle load [tf]
EP1M	NEVZ	Passenger electric locomotive	4,700	140	132	22.0
EP20	NEVZ	Passenger electric locomotive	7,200	200	129	21.5
TEP70BS	Kolomna plant	Passenger diesel locomotive	2,942	160	135	21.0
EP2K	Kolomna plant	Passenger electric locomotive	4,800	160	135	22.5

Source: IPEM based on data from manufacturers

locomotives which have been introduced since 2007. AC electric units are built at Kolomna, while DC electric locomotives come from TMH's Novochoerkassk facility. In addition, Kolomna produces diesel locomotives for

passenger trains, with Russia's total fleet consisting of 2,950 units. The current ratio of electric and diesel units in service is about 78:22. The technical characteristics of modern Russian locomotives are presented in Table 1.

## Freight transport and rolling stock

The railway's role in Russian freight transport is enormous: rail's share of the country's total freight turnover (excluding pipelines) was 87.1% in 2015 (Fig. 1). In total, in 2015 rail transported 1.327 billion tons of freight, with the leading commodities transported coal, with a 26.9% share, oil and oil products (19.9%), and mineral construction materials (17.9%).

Russian rail freight transport services use domestically-produced wagons, most of which have a 23.5-ton axleload. However, since 2012 Russian companies Uralvagonzavod and Tikhvin Freight Car Building Plant (TVSZ), which is part of United Wagon Company, began producing wagons with enhanced technical characteristics. This includes 25-ton axleloads, an extension of

the required overhaul period from 210,000km to 500,000km, and a service life increase from 22 to 32 years. Currently, these wagons make up less than 5% of the total in operation, but their share of production accounts for 60% of the wagons manufactured in 2015.

The total *freight wagon fleet* consists of 1.104 mln wagons of the types presented in Figure 2.

Russia's freight locomotive fleet consists of 11,900 units, 4,500 of which are AC electric locomotives, 3,800 are DC electric locomotives and 3,600 are diesel locomotives. Modern locomotives produced by Russian manufacturers now make up 19.4% of the fleet. The technical characteristics of Russia's modern freight locomotives are presented in Table 2.

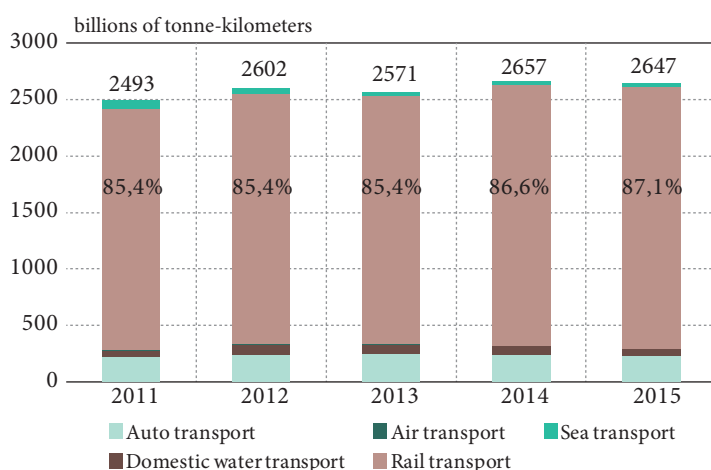
**Fig. 1.** Freight transport volumes in Russia in 2011-2015 (excluding pipelines)

Source: IPEM

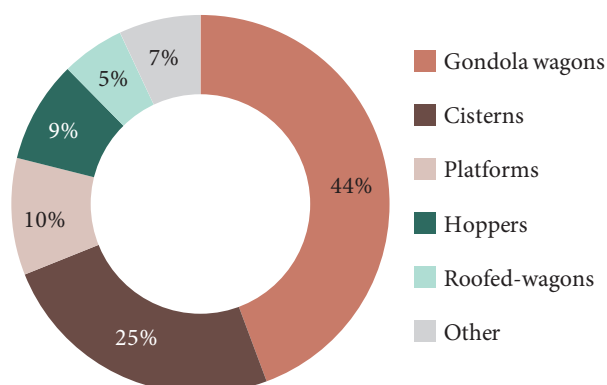
**Fig. 2.** The composition of the wagon fleet in Russia as of May 2016

Source: IPEM

**Table 2.** Technical characteristics of freight locomotives manufactured in Russia

Designation	Company	Locomotive type	Power [kW]	Speed [km/h]	Weight [t]	Axle load [tf]
2ES5K	NEVZ	Freight electric locomotive	6,560	110	192	24.0
3ES5K	NEVZ	Freight electric locomotive	10,000	110	288	24.0
2ES4K	NEVZ	Freight electric locomotive	6,400	120	192	24.0
2ES5	NEVZ	Freight electric locomotive	8,400	120	200	25.0
2TE25A	BMZ	Freight diesel locomotive	5,000	120	288	24.0
2TE25KM	BMZ	Freight diesel locomotive	5,300	100	288	24.0
2ES6	Ural Locomotives	Freight electric locomotive	6,440	120	200	25.0
2ES10	Ural Locomotives	Freight electric locomotive	8,400	120	200	25.0

Source: IPEM based on data from manufacturers

## The participants of Russia's rail transportation market

The Russian railway network's key player is of course state-owned Russian Railways (RZD), which operates the vast majority of freight and passenger services. RZD has around 20,000 locomotives, which is two-thirds of the total operating in Russia (Fig. 3). The company also owns the railway infrastructure and is responsible for maintenance.

Around 10,000 locomotives are owned by third-party industrial enterprises of railway transport (IERT). The majority of the IERT's fleet (89%) consists of diesel shunting locomotives, 95% of which are considered to have reached the end of their service-life.

Locomotive maintenance and repair is outsourced to manufacturers. Currently, 74.8% of RZD's locomotive fleet is serviced by TMH-Service, a subsidiary of TMH, with the remaining 25.2% serviced by STM-Service a subsidiary of Sinara.

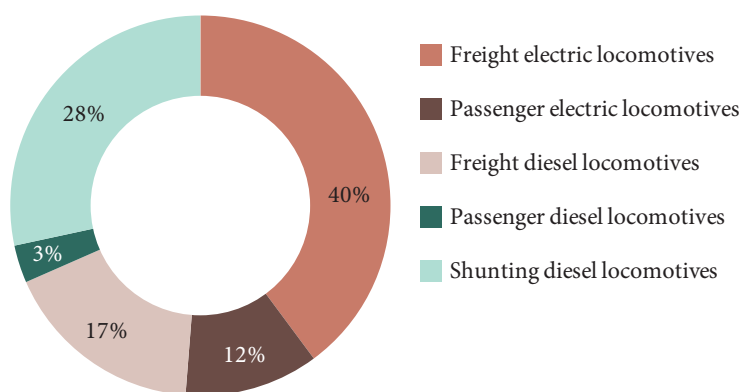

**Fig. 3.** The structure of the JSC «Russian Railways» locomotive fleet by the nature and type of service (as of 2015)

Source: IPEM

Long-distance and international passenger services are the responsibility of RZD subsidiary, Federal Passenger Company (FPC). FPC serves virtually all regions where railway infrastructure exists, with the exception of the Republic of Crimea and the Sakhalin region. In Crimea, passenger services are the responsibility of state-owned Crimean Railway. It has 546 coaches in its fleet, more than half of which have exceeded their service life. Another separate passenger company operates services on Sakhalin Island using a fleet of 50 coaches. Some transport between Moscow and St Petersburg is also carried out by a private company, Tver Express, which has a fleet of 36 coaches.

Suburban services are provided by 27 suburban passenger companies also owned by RZD and various Russian regions in all regions where railway transport is available. The majority of these services are unprofitable, and their activities are subsidized by the state.

Russia's freight wagon fleet is primarily managed by private companies. RZD subsidiaries hold 10.8% of the fleet, 8% of which is the responsibility of Federal Freight Company (FFC). Freight wagon operators do not own locomotives with RZD providing transport services apart from on a few specified routes. For example, Yakutia Railways operates services on an 808km line connecting with the Far Eastern Railway. In total there are more 700 small, medium and large freight rolling stock operators active in Russia, with 1,700 freight companies using their own fleet to transport goods.

## Features of rolling stock operation

Due to Russia's geographical location and the large size of the network, rail services operate in varying climatic conditions. This includes subarctic, temperate continental, continental, sharply continental, monsoon and subtropical conditions. As a result special attention is paid to the climatic conditions when designing and developing rolling stock for operation in Russia. According to current standards for the climatic performance of products, the operating temperature range of rolling stock manufactured for Russia is from -60°C to 40°C. The seriousness of these requirements is exemplified by the need for all rolling stock to operate on all sections of the network. For example, sometimes there is a need to redeploy a locomotive operated in the subtropical climate of the North-Caucasian Railway to the October Railway, part of which is located in the subarctic.

Climatic conditions can also vary on a single line. For example, a train travelling on the 1,000km Trans-Baikal railway may experience a temperature fluctuation of 25°C on a single trip. In highly humid conditions, such a change in temperature

will place additional strain on the rolling stock.

Another important feature of Russian rail transport is mixed traffic operation across almost the entire network, apart from the Moscow – St. Petersburg line where a minimal number of freight trains run. This inevitably imposes additional requirements both on the infrastructure and the rolling stock. In particular, maintaining track profile is critical on these sections because of the impact of heavy freight trains, which equates to a 20-25% increase in the cost of maintaining track.

Under mixed traffic operation, high-speed passenger trains are given priority, which can increase the time it takes to deliver goods as well as transport costs. Another direct consequence is the high intensity of operations. For instance, on the Ob' River – Omsk double-track section of the West Siberian Railway, more than 100 pairs of passenger and freight trains operate per day, while in the Kuzbass region, 40 pairs of trains operate on the Erunakovo – Bardino single-track line, virtually the limit of throughput on a single-track line.

## Production and maintenance of rolling stock

Russia's railway engineering market was worth an estimated €4.9bn in 2015. Activities include repair, maintenance and modernization services for rolling stock, and locomotive and freight wagon manufacturing (Fig. 4).

One of the major factors impacting the supply industry's continuing success is state investment in major projects. For example, a \$US 2.6bn contract for the supply of metro cars for Moscow Metro, which was awarded to Metrovagonmash, a subsidiary of TMH, stipulated the localisation of production levels to no less than 70% by the beginning of 2018. At the same time, the City of Moscow is funding the procurement and will pay equal monthly instalments over a 15-year period, guaranteeing payment to the manufacturer which will provide a consistent supply of cars.

This example also highlights another growing trend in rail transport and engineering – the transition to contracts based on lifecycle costs, with serving of these trains, which will be delivered between 2015 and 2020, conducted

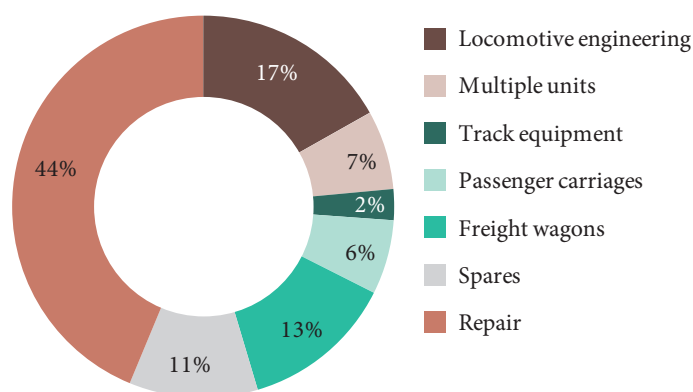

Fig. 4. Volume of the Russia's transport engineering in 2015 according to the cost of produced products

Source: IPEM

by the manufacturer throughout their entire 30-year service life.

### Production of locomotives

Six large enterprises are active in locomotive engineering in Russia, and with capacity to produce more than 800 units per year between

**Table 3.** Distribution of locomotive production by Russian enterprises according to the type of plant and the nature of work

Locomotives	Transmashholding			Sinara Group		Other
	Kolomna plant	BMZ <sup>1</sup>	NEVZ <sup>2</sup>	Ural Locomotives	LTZ <sup>3</sup>	KMZ <sup>4</sup>
Freight AC electric locomotives			✓			
Passenger AC electric locomotives			✓			
Freight DC electric locomotives			✓	✓		
Passenger DC electric locomotives	✓					
Passenger dual-system electric locomotives			✓			
Freight diesel locomotives		✓				
Passenger diesel locomotives	✓					
Shunting diesel locomotives		✓			✓	✓

them, they are able to meet RZD's requirements (see Table 3). Of course their annual production output depends almost entirely on RZD's capability to purchase new locomotives, and they have suffered a little recently with RZD's orders not exceeding more than 500-650 units per year.

#### Production of multiple units

Up to the end of 2014, the only domestic manufacturer of EMUs was Demikhovsky Engineering Plant (DMZ) another TMH subsidiary, which produces both AC and DC electric trains. However, in 2014 serial

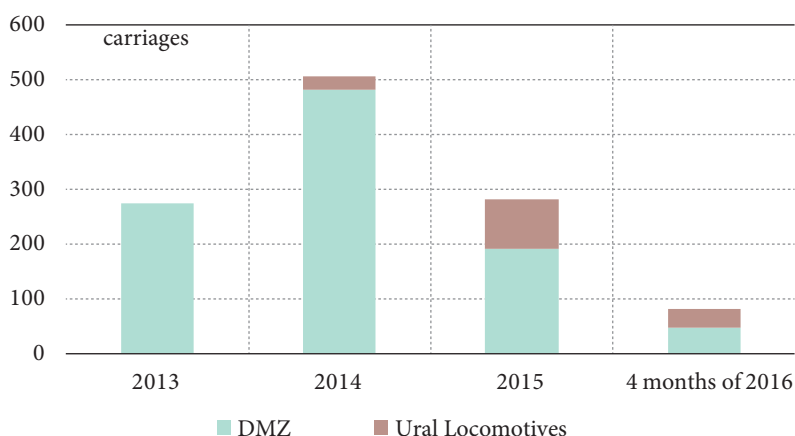
**Fig. 5.** Dynamics of production of electric train carriages by Russian enterprises

production of ES2G Lastochka (Desiro RUS) DC trains was initiated by Ural Locomotives, a joint venture of Siemens and Sinara. As a result, in 2015 DMZ share of the total output of electric rolling stock fell to 68%, and to 57.3% in the first four months of 2016 (Fig. 5).

#### Production of passenger coaches

Currently Tver Carriage Works is the sole manufacturer of passenger coaches in Russia. However, with FPC not having sufficient funds to replace rolling stock as required, production of passenger coaches has fallen by almost four times in the past three years, from 517 units in 2013 to 131 in 2015.

#### Production of freight wagons

In contrast several companies manufacture freight wagons, with more than 10 active at the beginning of 2016. The largest producers are Uralvagonzavod and United Wagon Company, which owns Tikhvin Freight Car Building Plant. However, while they have increased production in recent years, a current surplus of freight rolling stock using the Russian network means that demand has decreased significantly (Fig. 6). The structure of production according to wagon type is shown in Figure 8.

<sup>1</sup> Bryansk Engineering Plant

<sup>2</sup> Novochoerkassk Electric Locomotive Building Plant

<sup>3</sup> Ludinovskiy diesel locomotive plant

<sup>4</sup> Kambarka Engineering Plant



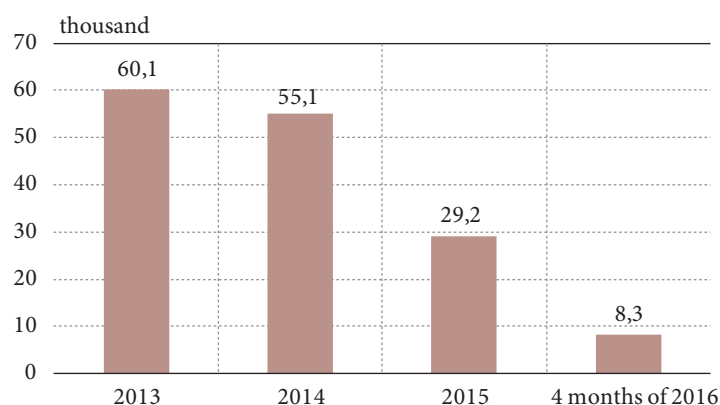

Fig.6. Dynamics of production of freight wagons in Russia

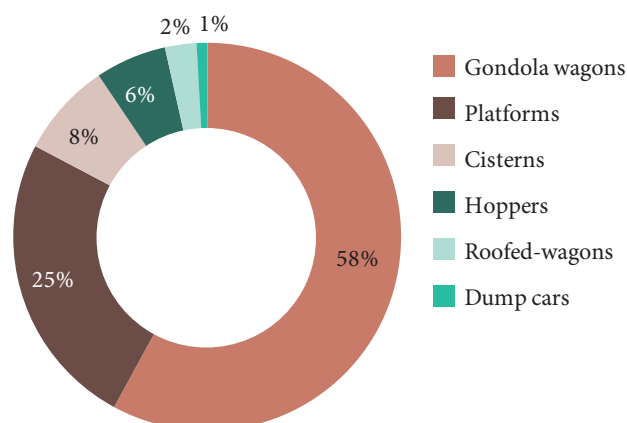

Fig. 7. Structure of production of freight wagons in 2015

## Problems and prospects for the development of railway transport and transport engineering in Russia

The systemic problem impacting rolling stock production in Russia is the lack of long-term demand for goods and the related reduction in investment in manufacturing enterprises.

While the total investment in the fixed assets of transport engineering enterprises increased by 16% year-on-year from €280.7m to €325.8m in 2015, investment in R&D by manufacturers decreased by 5% from €18.3m to €17.4m.<sup>5</sup> At the same time, different areas have their own trends. So, if the investment in the fixed assets of locomotive manufacturers increased by 64% from €72.8m to €119.4m during the same period<sup>6</sup>, the reverse is observed in freight wagon production where investment has almost entirely stopped from €69.9m in 2014 to €0.8m last year.<sup>7</sup>

At the same time, manufacturers, state bodies and participants in the transport industry continue to search for solutions to the problems. For example, the Institute of Natural Monopolies Research (IPEM) has developed a

program<sup>8</sup> to address the needs of the Industry and Trade Ministry of Russian Federation, which includes measures for stimulating the growth of rail transport and increasing the production and operation of modern rolling stock with improved technical characteristics. In 2012-2016, Rubles 21.9bn (\$US 341.5m) was allocated to subprogram no. 6.

One area under development is RZD's heavy trains program. This involves increasing the weight of freight trains by improving rolling stock performance. Activities include preparing railway infrastructure for use by freight trains with an axle load of 25 tons with a view to increasing this to 27-30 tons in the future.

The program envisages the acquisition of high-power locomotives, new freight wagons with higher load capacity, as well as modernizing permanent way and man-made structures. RZD's 2016-18 investment program allocates Rubles 440.3bn (\$US 6.9bn) to the initiative.

## Between East and West

Cooperation with foreign manufacturers, predominately from Western Europe, has been a major area of development in order to encourage technology localization in Russia.

However, the extent of these activities has been scaled back recently due to the current difficult global political and economic situation. In particular, constraints were caused as a result

<sup>5</sup>Data for 2015 year are provided taking into account the rate of exchange in 2014. Taking into account the exchange differences in 2014 and 2015, due to the reduced value of the ruble against the euro there was a decrease of investments into fixed assets from € 280.7 million to € 244.3 million and decrease of investments into R&D from € 18.3 million to € 13.1 million.

<sup>6</sup>Taking into account the rate of exchange in 2014

<sup>7</sup>Also taking into account the rate of exchange in 2014

<sup>8</sup>Subprogram no. 6 – «Transport engineering» – part of State Program «Development of the industry and increasing its competitiveness» approved by RF Government Decree no. 328 of 04/15/2014

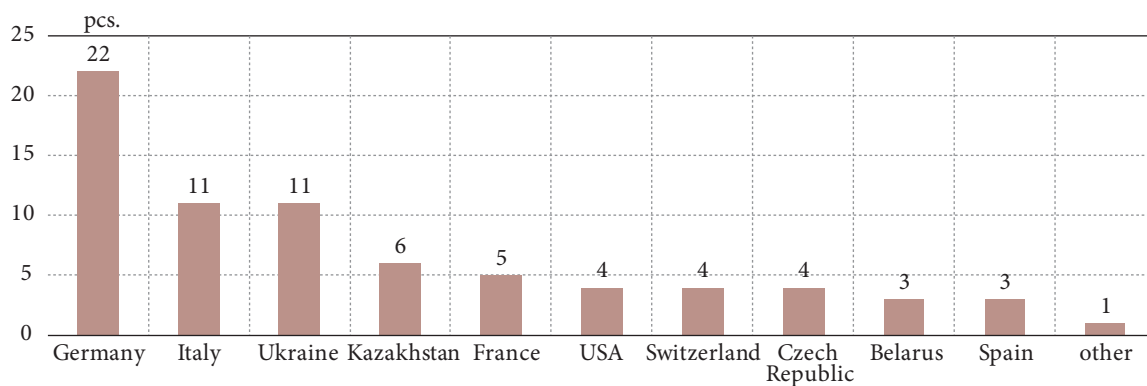

Fig. 8. Number of items supplied by foreign countries (import of large components for locomotives into Russia)

Source: IPPEM

of so-called «economic sanctions» against Russia.

At the same time, Asian suppliers, particularly from China, are actively looking to enter the Russian rolling stock and components market, specifically to supply the proposed 772km Moscow – Kazan high-speed line. This is one of the most promising railway developments in Russia and is budgeted at about Rubles 1 trillion (\$US 16.4bn). According to preliminary data, the line will require 29 20-car high-speed trains. Chinese companies have shown significant interest in participating in the project, although specific participants have not been finalized as the conditions for cooperation remain under discussion.

Russian rolling stock manufacturing remains dependent on imported components, with locomotive production utilizing around 34 units provided by international suppliers. German companies have the largest representation in the Russian market, providing 22 large components such as high-voltage protection devices, and air

distributors for brake systems. Italy and Ukraine account for 11, while Kazakhstan supplies six items, France five, and the United States, Switzerland and the Czech Republic provide four items each (see Figure 9).

Importing these units results in a significant increase in the cost of the final product. However, manufacturers are left with little choice due to a lack of competence among Russian companies as well as a general lack of quality, or their inability to supply the required quantities at an acceptable cost.

Localizing foreign manufacturing in Russia is one way of reducing the cost of production. However, the prospective investment costs must be considered with potential demand for specific components, which may be negligible. But with the current low value of the Ruble, the cost of maintenance and repair of imported components has increased, substantiating the argument for localisation.

## The development of the internal market

In 2015, Crimea's railway was incorporated into the Russian system. This corner of the expanded network has enormous potential for growth of both passenger transport and freight by connecting with the peninsula's ports. However, to realise this, the rail system requires a substantial upgrade.

Plans to develop the region are increasing demand for the transport of building materials required to construct commercial and residential properties and to build and rehabilitate roads and railways. Crimea's more than 40 industrial enterprises are another potential source of demand for freight services.

Almost all of Crimean Railway's rolling stock has exceeded its service life, including its fleet

of suburban multiple units. According to data from the Crimean Railway, in 2016-2017 101 of its 132 operational locomotives and each of its 823 passenger coaches will exceed their service life. Taking into account the average price of locomotives and coaches, Crimea's rolling stock market is potentially worth Rubles 51.5bn (\$US 804.7m.)

Developing the Crimean peninsula is a major priority for the Russian Federation and in the coming years we can expect a significant investment in the region. This will include both infrastructure development and rolling stock renewal, which is likely to include orders from foreign companies. §

## Supporting Russian engineering export



**Mikhail Mamonov,**  
Director for International Projects of the Russian Export Center (REC)

In the current business environment, a major focus of Russia's national industry development is to provide incentives for companies to boost their exports. The decline in the value of the ruble has created some advantages for Russian products in overseas markets, while greater export activities could help Russian manufacturers to grow in scope and influence.

### Export Dynamics

High-tech industries are playing an increasingly critical role in today's world, and Russia is no exception. There has been a marked upward trend in the export of Russian high-technology products over the last four years. The market was worth \$US 11bn in 2015, an increase of nearly 50% from \$US 7.4bn reported in 2011. And this trend is expected to continue.

The export volume index for non-primary commodities has similarly increased by 6.3%, including a 14.9% increase for high value added products, and 8.4% for machinery and equipment.

However, the growth of exports of non-primary commodities was accompanied by a decline in value due to the drop in national currency rate and falling prices of a wide range of natural resources. Despite this, even when the model does not include petroleum products, metals and other low added-value commodities, which have also experienced falling prices, there was still no reduction in the volume of non-primary export in value terms.

Moreover, the commodity and geographical diversification of Russian exports expanded, with machinery's share growing to 16% of the

total value of non-primary exports in 2016 compared with 12% in 2012.

In 2015, the value of Russian heavy machinery exports reached \$US 7.6bn, which was only a slight decrease compared with 2014 figures (-0.02%). These results are primarily the outcome of growth in shipbuilding, specifically research and naval vessels, and a small reduction in cost of supplying power-generating equipment. From 2013 onwards, the key Russian export items are turbo jet engines with output over 25kN, which in 2015 was worth \$US 1.4bn or 18.3% of the total market; fuel elements (\$US 1.3bn. or 17.1%); and ships, including research and naval vessels (\$US 1.3bn or 16.7%).

The major markets for Russian heavy machinery products in 2015 were China, which accounted for \$US 1.4bn or 17.8% of the total value of exports, Ukraine (\$US 700m or 9.7%), Vietnam (\$US 600m or 8.0%), Kazakhstan (\$US 600m or 7.4%), and Japan (\$US 400m or 5.2%).

Exports to China have grown over the past two years mainly due to increase in export of turbojet engines and components for nuclear reactors. A similar positive trend is also evident in figures from the Republic of Korea following the exports of petroleum tankers, tugboats and other ships.

### Engineering Export Support System

Over the past few years, the government has taken an active role in developing an export support system, and almost all financial and non-financial tools to achieve this are now in

place. The Russian Export Center (REC) was established at the end of 2014 by the Russian government to assist companies looking to export by improving the efficiency of export support

activities and systems. The government considers boosting exports as one of the central priorities for its national economic development policy, and creating such an institution was a logical step and is consistent with existing international practices.

The export support system comprises relevant ministries and agencies including the Ministry of Economic Development, Ministry of Industry and Trade, Ministry of Finance, Federal Customs Service, and the Federal Tax Service of the Russian Federation.

It also encompasses development institutions such as the State Corporation Bank for Development and Foreign Economic Affairs (Vnesheconombank), the Russian Export Center Group including Export Insurance Agency of Russia (EXIAR) and Eximbank of Russia, as well as Russian trade representative offices and overseas Russian embassy economic sections. In addition, the system includes regional infrastructure represented by local export support centers, regional integrated centers (RICs), local agencies of Ministry of Industry and Trade of Russia, and regional chambers of commerce and industry.

The export support tools may be divided into financial services covering credit and insurance support for export transactions; provision of state guarantees and various subsidies; and non-financial support for exhibition and trade fair activities. The group also organizes trade missions, consultations, and works to improve regulatory frameworks, including the roadmap of the Agency for Strategic Initiatives' (ASI) "Promotion in Foreign Markets and Export Support," as well as drafting an export support bill. It also supports efforts encouraging the lifting of trade barriers and restrictions, and lobbying of Russian exporters' interests through intergovernmental commissions.

One priority area for REC is the development of high-tech exports. In 2015, the Russian Export Center Group supported exports of engineering companies amounting to Rubles 48bn, primarily through insurance and soft lending tools for export contracts. Companies working in the automotive, transport and power engineering sectors have already benefitted, including Kamaz; Metrowagonmash; Yarovit Energo;; Power Machines. Indeed, more than 100 projects worth more than Ruble 500bn are currently addressed by REC.

It is already clear that in order to maintain the positive trend in Russian exports, REC's tools and support will increasingly be required. Moreover, with regard to best practices of back-to-back export financing, a need expressed by engineering companies' representatives, one cannot overstate the Soft Interest Lending Program for high-tech companies that proved itself as an efficient tool in 2015. For example, under the High-tech Exports Support Program the following fixed interest rates were used in 2015: 5.75%, for loans denominated in Russian rubles and granted to importers; 7.65%, for ruble loans granted to exporters; 2-3.5% for US dollar loans; and 1-2% for Euro-denominated loans.

Federal grants awarded in 2015 amounted to Rubles 3bn, while the value of loans offered by Eximbank of Russia was Rubles 26bn. Export revenues and tax revenues from supported export contracts exceeded Rubles 100 bn.

The Russian government's Stable Social and Economic Development Plan, which was announced on March 1, 2016, anticipates possible budgetary allocations to support Russian companies looking to export but put off by international tariffs and fees. This is dependent on the confirmation of funding sources in the second half of 2016, and REC is hopeful that high-tech companies, including manufacturers, will benefit from this tool which promises to make them more competitive with their international competitors.

Slight alterations of the program are promised for this year by extending it to importers of Russian products and their banks.

The high-tech commodities covered by Eximbank's support program were identified following consideration of the national economy's modernization priorities and were approved by the Ministry of Industry and Trade through its Order No 1809, which was agreed on July 2 2015.

The support program is attractive both for small and medium size businesses and for companies that are familiar with implementing large projects, such as the recent order for rail wagons from Hungary which was worth Rubles 4bn, and orders from Azerbaijan and Kazakhstan which were worth about Rubles 3bn. In addition, Kamaz recently signed contracts under the support program to supply vehicles to Kazakhstan and Vietnam.



**Table 1.** Leaders for Russian non-energy export growth

Country	The volume of Russian exports, \$ mln				Average growth rate	The main Russian export commodities in 2015
	2012	2013	2014	2015		
Iraq	286	377	1,758	1,807	+84,9%	Aircrafts, Radar Equipment, Softwood Lumber
Vietnam	1,348	1,336	1,407	1,692	+7,9%	Vessels, Aircrafts and Weapons, Radar Equipment, Potash Fertilizers
Peru	354	400	436	618	+20,4%	Aircrafts, Nitrogen Fertilizers, Petroleum Products
Ecuador	116	192	212	260	+30,7%	Petroleum Products, Nitrogen Fertilizers, Metal Constructions from Ferrous Metals
Oman	41	57	86	100	+34,6%	Wheat, Barley, Light Petroleum Products, Potash Fertilizers

With regard to support of machinery and equipment exports, REC' clients include companies such as Evraz, Uraltransmash, and United Wagon Company. Financial and non-

financial support measures are available and the total value of heavy engineering projects under implementation by REC now amounts to nearly \$US 6bn.

## Sectoral Support

The Russian Export Center's activities involve working closely with key sector representatives, experts, and relevant agencies to provide universal support measures. Work for prospective export companies includes preparation and execution of individual export support agreements, and prioritizing market entry plans.

Upon linking up with the REC, the client company signs an individual support, and the subsequent support scheme is developed, agreed and signed between REC's chief executive officer and the client's chief executive.

The support scheme may include:

- preparation of market analyses,
- identifying potential markets,
- assistance in finding partners abroad,
- assistance during negotiations and legal support,
- preparation of documents,
- holding trade missions,
- support in customs administration, certification, and customization,

- assistance in patent application, and
- offering project financial support.

The Russian Export Center holds regular meetings with the Russian Engineering Union's member-companies, where together they identify the challenges and difficulties impeding the development of the export of machinery and equipment, and prepare follow-up plans addressing any potential difficulties. Another objective is to develop REC's capabilities in promoting Russian high-tech products in external markets, including through incorporation of Russian companies into industrial and infrastructure programs implemented by developing countries. REC participates in the work of the intergovernmental commission, and in collaboration with relevant ministries and agencies, addresses the issues holding back improvements in the business environment, production development, and compliance of Russian products with international requirements and standards. 

# Statistics of Russian Railway Industry

The statistic material was prepared by the Institute of Natural Monopolies Research (IPEM). Source: official data of Russian state authorities, Russian Railways JSC, rolling stock manufacturers. For more actual and broaden data (including regular updating) contact the IPEM specialists: +7 (495) 690-14-26, ipem@ipem.ru, www.ipem.ru

## Production figures

Production of railway industry in Q2 of 2015-2016

Type	Q2 2015	Q2 2016	Q2 2016/Q2 2015
<b>Locomotives, units</b>			
Main Line Diesel Locomotives	41	62	151%
Main Line Electric Locomotives	91	70	77%
Diesel Shunters	42	43	102%
Mine Electric Locomotives	6	3	50%
<b>Cars, units</b>			
Freight Cars	6,566	7,053	107%
Passenger Coaches	47	89	189%
EMU & DMU Cars	78	109	140%
Metro Cars	30	62	207%
Tram Cars	18	18	100%

## Locomotives

Locomotive production in Q2 of 2015-2016 on monthly basis, units

Type	2015				2016			
	April	May	June	Q2	April	May	June	Q2
Main Line Diesel Locomotives	12	12	17	<b>41</b>	20	21	21	<b>62</b>
Main Line Electric Locomotives	32	27	32	<b>91</b>	24	21	25	<b>70</b>
Diesel Shunters	12	15	15	<b>42</b>	18	11	14	<b>43</b>
Mine Electric Locomotives	2	2	2	<b>6</b>	1	2	0	<b>3</b>

Locomotive production in 2015-2016 on quaterly basis, units

Type	2015				2016	
	Q1	Q2	Q3	Q4	Q1	Q2
Main Line Diesel Locomotives	12	41	47	67	54	62
Main Line Electric Locomotives	72	91	61	54	55	70
Diesel Shunters	22	42	42	64	34	43
Mine Electric Locomotives	6	6	1	6	0	3

Main Line Locomotive production in 2015-2016 on quarterly basis, units

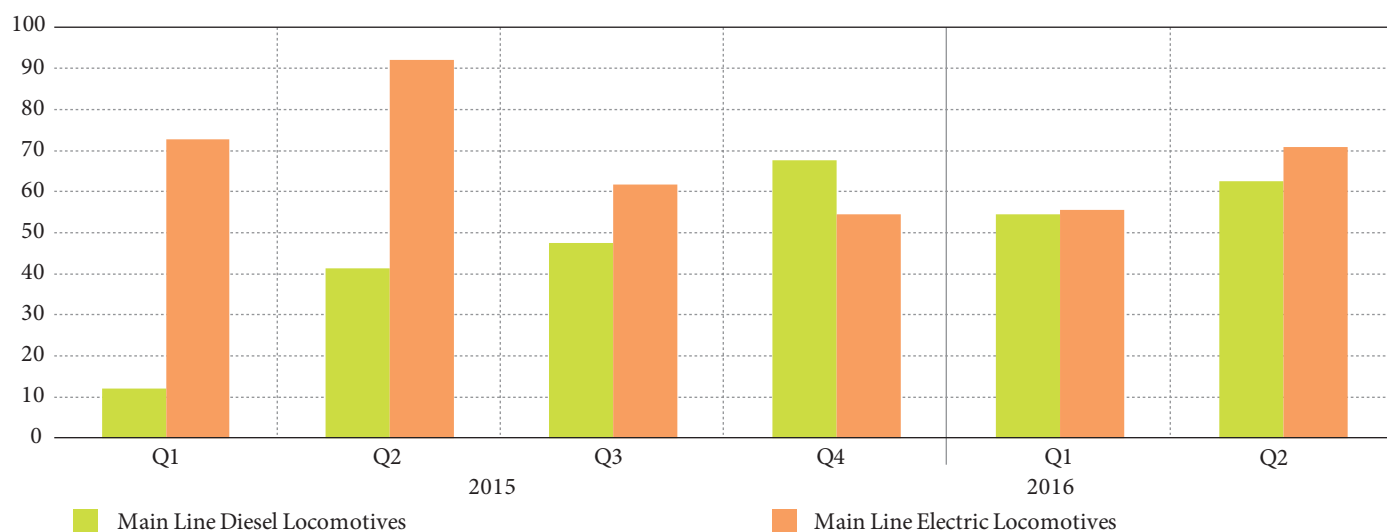

Main Line Electric Locomotive production by manufacturers, Q2 2015-2016

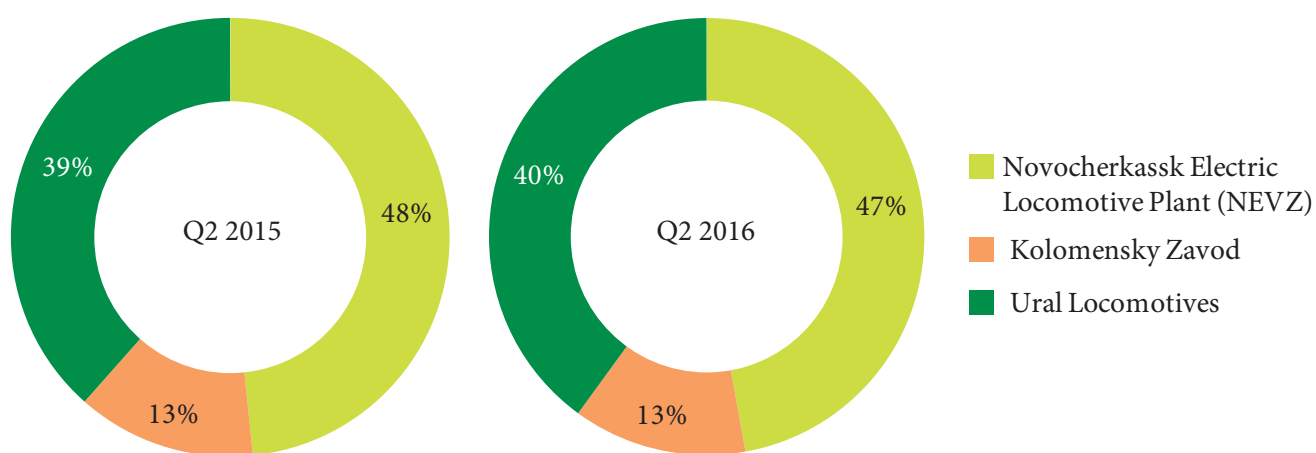

Main Line Diesel Locomotive production by manufacturers, Q2 2015-2016

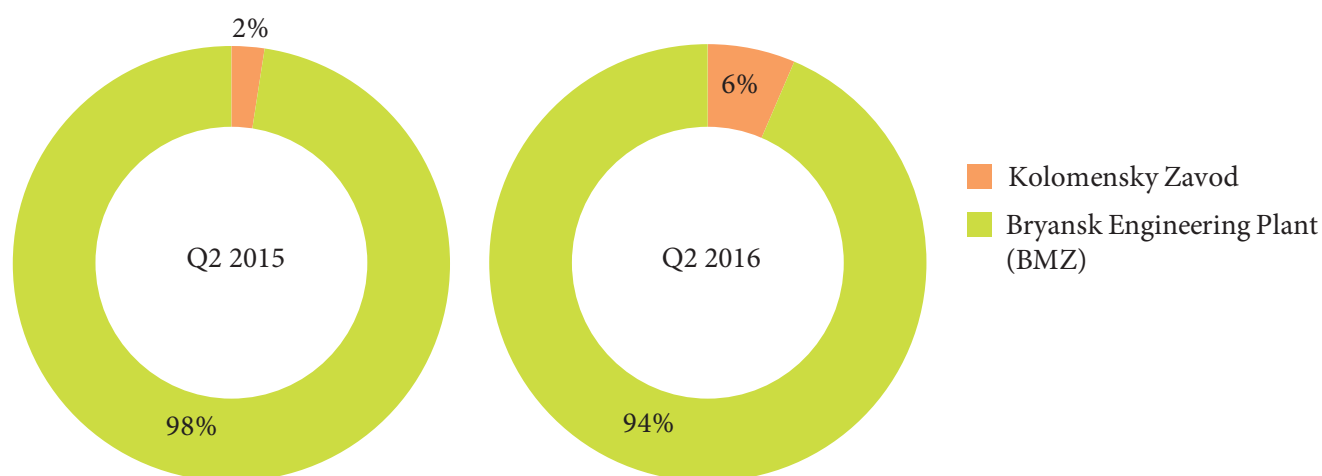

Diesel Shunters production by manufacturers, Q2 2015-2016

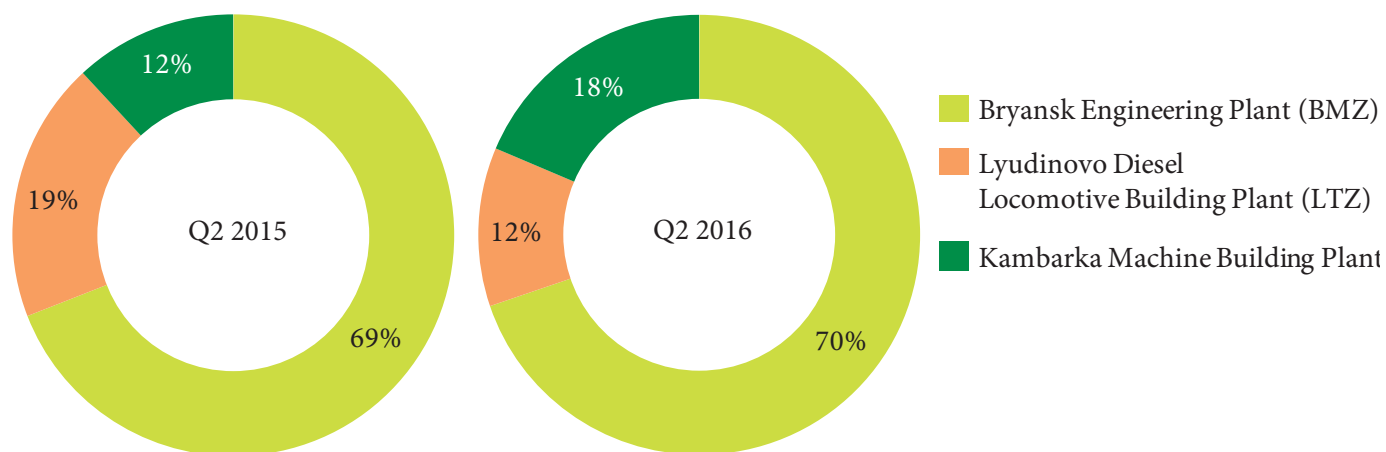

### Cars

Cars production in Q2 of 2015-2016 on monthly basis, units

Type	2015				2016			
	April	May	June	Q2	April	May	June	Q2
Freight Cars	2,286	2,150	2,130	<b>6,566</b>	2,148	2,663	2,242	<b>7,053</b>
Passenger Coaches	4	17	26	<b>47</b>	34	15	40	<b>89</b>
EMU & DMU Cars	17	24	37	<b>78</b>	34	31	44	<b>109</b>
Metro Cars	14	8	8	<b>30</b>	22	16	24	<b>62</b>
Tram Cars	6	7	5	<b>18</b>	12	6	0	<b>18</b>

Cars production in 2015-2016 on quarterly basis, units

Type	2015				2016	
	Q1	Q2	Q3	Q4	Q1	Q2
Freight Cars	6,374	6,566	6,589	9,290	6,292	7,053
Passenger Coaches	14	47	24	46	42	89
EMU & DMU Cars	15	78	75	113	53	109
Metro Cars	55	30	36	64	58	62
Tram Cars	1	18	9	12	19	18

Freight Cars production in 2015-2016 on quarterly basis, units

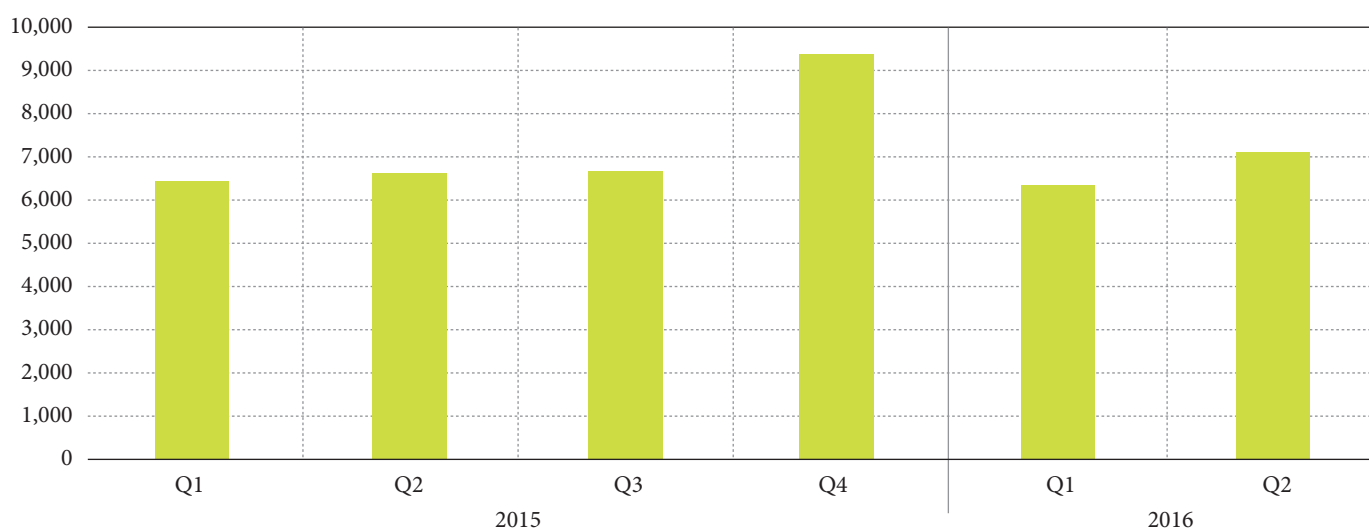



Freight Cars production in 2015-2016 on quarterly basis, units

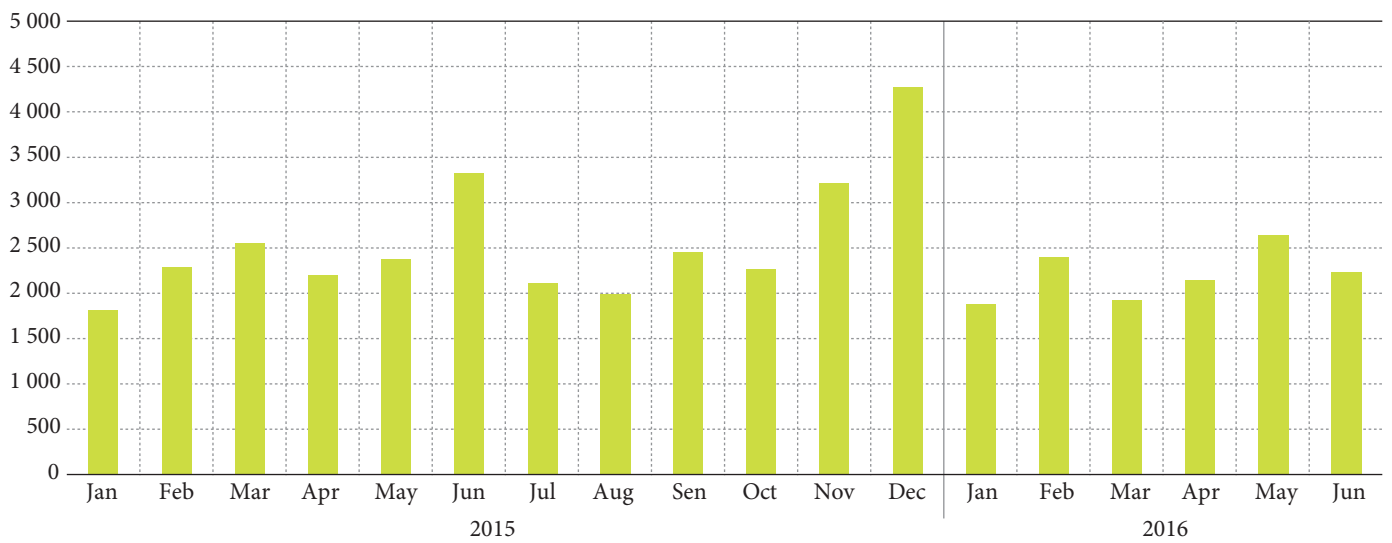

Passenger Coaches production in 2015-2016 on quarterly basis, units

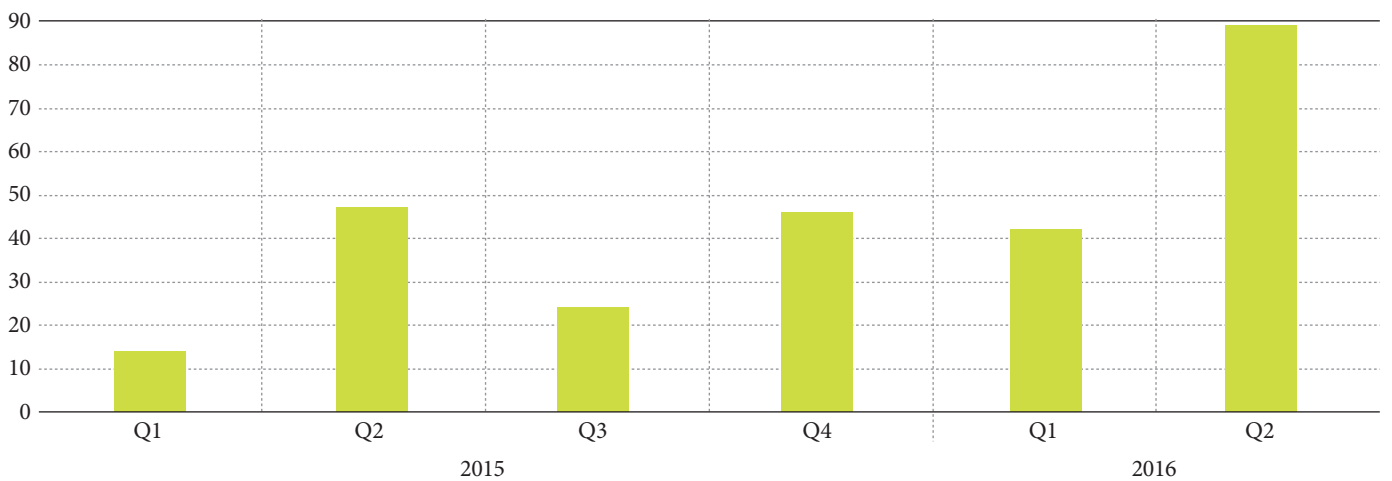

Tram Cars production in 2015-2016 on quarterly basis, units

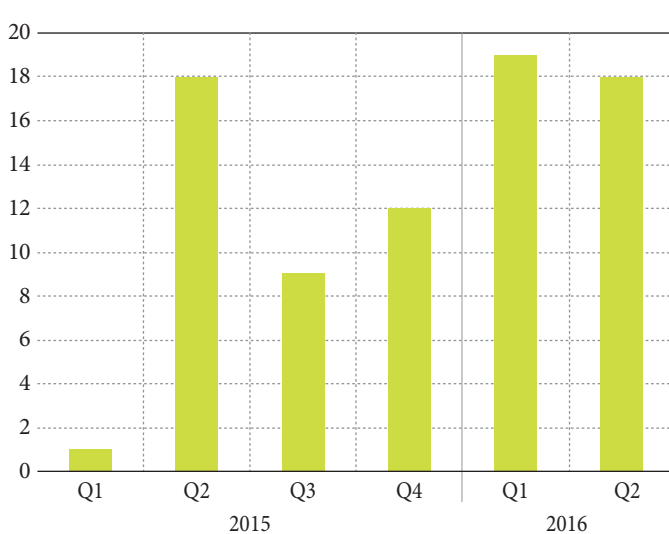

EMU Cars production in 2015-2016 on quarterly basis, units

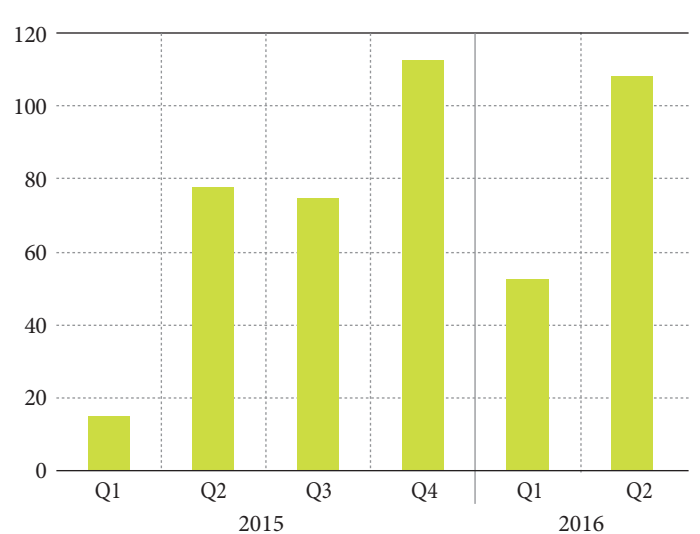

Freight Cars production structure in Q2 of 2015 and 2016

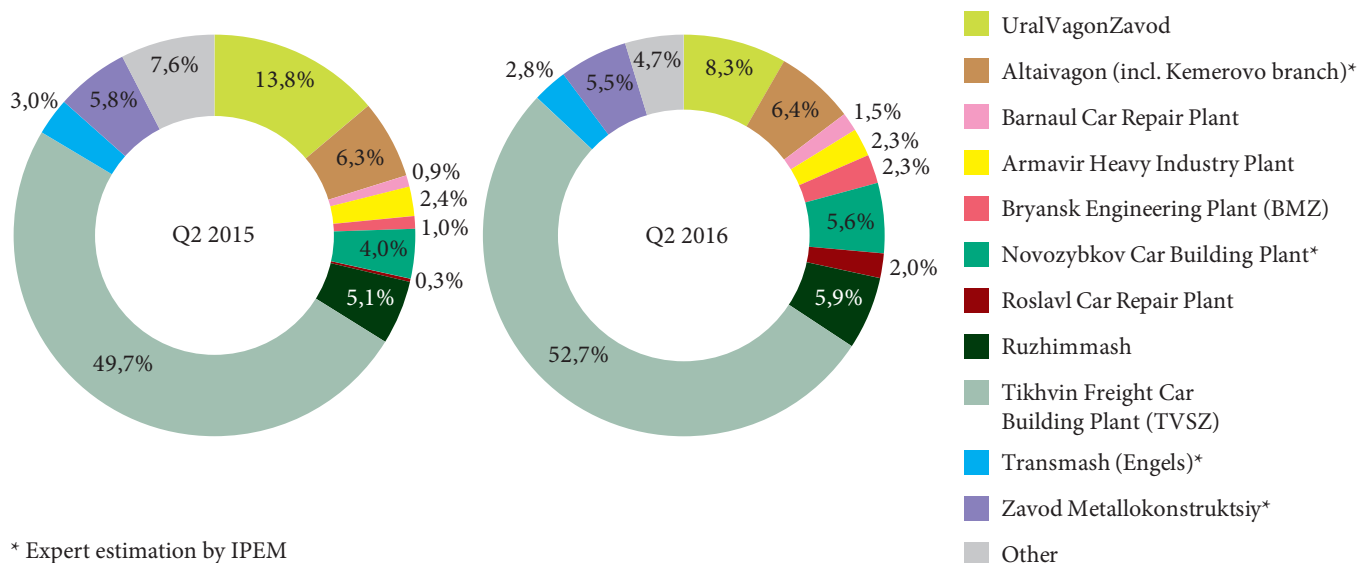

\* Expert estimation by IPEM

### Economical Figures

Amount of railway industry production and services sold, exclusive of VAT, mln euro

Type of production	Jan - Jun										
	2015							2016			
	Q1	Q2	H1	Q3	Q4	H2	Y	Q1	Q2	H1	2016 H1 / 2015 H1, %
Production of Rolling stock	1,040.25	1,411.93	2,452.18	1,210.44	1,257.68	2,468.12	4,920.30	901.31	1,431.28	2,332.60	95%
Locomotives	147.46	211.06	358.52	257.75	211.18	468.93	827.44	150.66	239.48	390.14	109%
EMU & DMU Cars, Metro Cars, Tram Cars, Locotractors	106.80	79.77	186.58	59.79	81.28	141.07	327.64	75.85	145.13	220.97	118%
Track Machines	21.07	49.12	70.18	22.16	39.22	61.37	131.56	10.75	15.29	26.04	37%
Passenger Coaches	32.17	108.39	140.56	78.58	94.70	173.28	313.83	21.41	145.53	166.94	119%
Freight Cars	120.92	135.34	256.27	190.54	183.99	374.52	630.79	202.01	287.45	489.46	191%
Production of Spare Parts of Rolling Stock and Track	90.14	156.04	246.19	144.06	148.55	292.62	538.80	89.69	145.70	235.39	96%
Repair and Maintenance of Rolling Stock	521.68	672.20	1,193.89	457.57	518.03	975.60	2,169.49	350.95	452.71	803.66	67%
Total Industry	1,040.25	1,411.93	2,452.18	1,210.44	1,257.68	2,468.12	4,920.30	901.31	1,431.28	2,332.60	95%
Exchange rate, RUB/EUR	71.02	58.26		70.14	72.38			82.69	72.63		



## Reliable brake systems guarantee railway safety

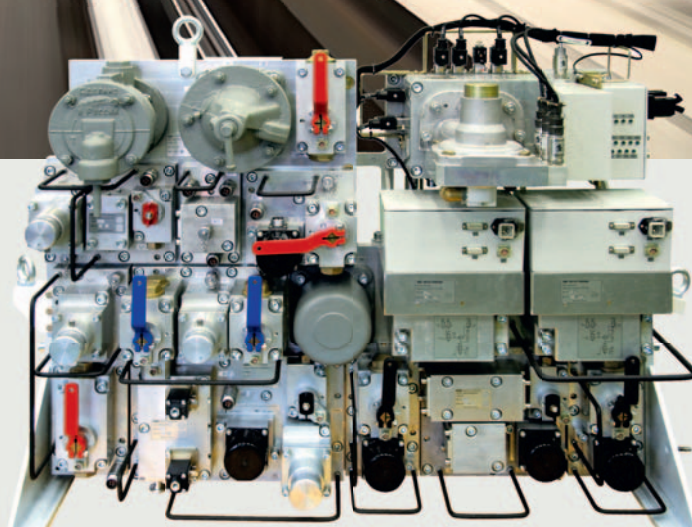

MTZ TRANSMASH is a leading Russian manufacturer of brake systems and pneumatic and electro-pneumatic brake components, all of which enhance railway rolling stock safety.

Founded in 1921, MTZ TRANSMASH launched Russia's brake-system industry, and 95 years on, the company continues to develop and produce brake equipment for all types of freight wagons, passenger coaches, locomotives, electric and diesel multiple units, high-speed trains and metro trains.

Our brake equipment products are designed with the unique operational features and specificities of the Russian railway network in mind, namely:

- long mileage
- operation of rolling stock in sparsely populated areas
- difficult terrain, including sharp gradients, and
- a wide variety of climatic conditions and temperatures ranging from 60° to -60° Centigrade.

Brake equipment manufactured by MTZ TRANSMASH is now in use on rolling stock operated on main line railways and metro lines in countries in Europe, Asia, Africa and Latin America.

MTZ TRANSMASH is interested in creating and strengthening its business ties with railways, industrial enterprises, companies and other consumers of our products.

## Gas-turbine locomotive on liquefied natural gas



**Valery Kossov,**  
PhD, Prof., CEO of VNIKTI JSC

Changeover of a considerable part of vehicles to gas fuel is one of the most important trends of the Russian's Energy Strategy<sup>1</sup>, which provides usage of natural gas as a motor fuel and develops Gas-to-liquids (GTL). As Russia's President Vladimir Putin said, the question about extension of a gas usage as a motor fuel concerns energy efficiency, transportation cost-cutting and improving the environment<sup>2</sup>.

### Case history

Energy Strategy of Russian Railways JSC<sup>3</sup> offers three indexes of diesel to natural gas fuel conversion by 2030: 10%, 25% and 50%, or from 366 thousand tonnes to 1,830 thousand tonnes. Middle index – 25% diesel to natural gas fuel conversion (915 thousand tonnes) – is considered to be the most acceptable one in view of gas supply infrastructure development, locomotive engineering capacity, gas-producing and gas-processing industries.

Natural gas can be stored in a gaseous or liquefied state on board of a vehicle.

Undoubtedly, liquefied natural gas (LNG) is a more complex fuel type in terms of technology. It is a cryogenic liquid which preserves itself at very low temperatures. LNG's boiling point (that is the temperature at which it begins to evaporate) is 160°C. LNG production, its storage and transportation require special equipment. LNG's main advantage is that during liquefaction the gas volume is reduced by 600 times. In practice, this means that in course of gasification at a pressure close to atmospheric, 600 volumes of natural gas are formed from a volume of the LNG and, consequently, the running per fueling is increased substantially.

"Types and basic parameters of the locomotives" approved in 2002 provided development of freight electric locomotives

with section's power of 6,000 kW (6-axis) and freight diesel locomotives with power of 3,500 kW (per section) and with axle load up to 25 tonnes. Creation of more powerful diesel locomotives is limited diesel engines capacity which can be placed in the locomotive body.

Creating an autonomous locomotive was considered to be necessary, which would be equal to a diesel locomotive in terms of efficiency and reliability and would be able to take a 6,000 tonnes train from an electric locomotive and deliver it without reforming to the destination.

To solve the problems of diesel motor fuel conversion to alternative fuel types within the scope of the Russian Railways Energy strategy, in 2005 VNIKTI JSC began developing a main-line gas-turbine freight locomotive GT1-001 of 8,300 kW power with a power unit based on a gas-turbine engine (GTE) running on natural gas in accordance with instructions from the Russian Railways company.

To reduce the time for developing and manufacturing the prototype, it was decided to develop a gas-turbine locomotive based on the underframe of the operated 12-axle electric locomotives VL15 (Fig. 1).

Gas-turbine locomotive GT1-001 consists of two sections. Power equipment (GTE, traction

<sup>1</sup> Approved by the RF Government's Decree from 28.08.2003 number 1234r. The Concept of a long-term social and economic development of the country until 2020 year was approved by Decree of the RF Government from 17.11.2008 number 1662r.

<sup>2</sup> Vladimir Putin. Meeting on the prospects of the gas-motor fuel usage. 14.05.2013.

<sup>3</sup> Approved by Decree of Russian Railways JSC from 15.11.2011 number 2718r.





Fig. 1. Gas-turbine locomotive GT1-001

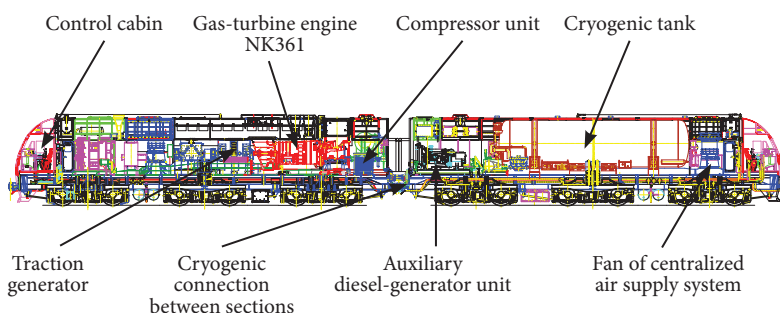

Fig. 2. The gas-turbine locomotive GT1 equipment layout based on the underframe of electric locomotive VL15

generator) is located in one section. Cryogenic tank for LNG storage and fuel supply system are located in another section. The LNG allows to place a fuel margin of 17 tonnes to run without fueling up to 700 km. The gas-turbine locomotive GT1 equipment layout is shown in Figure 2.

A gas-turbine engine was developed and manufactured at the Kuznetsov JSC (city of Samara) which is experienced in creating and testing cryogenic fuel engines (LNG and hydrogen) for aviation. A prototype of a locomotive gas-turbine engine was previously used in the experimental plane Tu-155. Development of this plane formed the necessary experimental basis for cryogenic equipment tests and the highly skilled team of in the field of cryogenic engineering was gathered.

Special cryogenic tank (Fig. 3) with shut-off and regulating equipment and flexible connections between sections was designed and manufactured at the Uralkriomash JSC (city of Nizhny Tagil).

The Electrotyajmash-Privod enterprise (city of Lysva) has designed and manufactured a special transport high speed (6,000 RPM)

traction generator. Gas-turbine locomotive general assembly was performed at the Voronezh diesel locomotive repair plant – a Russian Railways JSC branch. Technical parameters of the gas-turbine locomotive GT1-001 are shown in Table 1.

The first trips of the gas-turbine locomotive GT1-001 on liquefied natural gas took place at the Kuibyshev Railway in 2008. The positive results of these trips allowed to organize operation of the gas-turbine locomotive at the Moscow railway, where 7 heavy freight 10,000 tonnes trains were driven from November 2008 to February 2009 (this is much more than the weight norms for trains with electric locomotives adopted for these railway sections).

At the VNIIZhT experimental ring on January 23, 2009 and September 7, 2011 the gas-turbine locomotive drove 15,000 and 16,000 tonnes freight trains. These are the world records for a single autonomous locomotive with one power unit in the head end of the train. In October 2009, Russian Railways obtained a Guinness Book of Records certificate for creating the most powerful gas-turbine locomotive in the world – GT1-001.



Fig. 3. Cryogenic tank

Table 1. Technical parameters of the gas-turbine locomotive GT1-001

Parameters	Value
Power of all GTE, kW	8,300
Number of traction axes	12
Tractive effort of long-time mode, kN	620
Fuel margin, t	17
Cruising range without refueling, km	700



Fig. 4. Gas-turbine locomotive GT1h-001

The following innovations have been developed and successfully applied on the gas-turbine locomotive in course of further research and development:

- a unique joint control and regulation system for GTE and traction generator, which provides necessary acceleration and energy efficiency in traction modes when driving 6,000 tonnes trains and in idling modes of the gas-turbine locomotive's GTE which fulfils the railway transport requirements,
- an innovative system of gas treatment with minimizing the time for cooling avoiding gas release into the atmosphere,
- a new design of a flexible LNG transfer at high pressure from section to section which eliminates tensile, compressive and torsional loads on the metal hose that provides necessary service life, and
- an innovative system of oil supply for GTE and generator bearings with cooling oil using cryogenic fuel.

In addition, technical solutions for changeover of the locomotive to the hybrid electric drive of shunting mode using traction batteries were implemented. At the same time an auxiliary diesel-generator with diesel fuel reserve was excluded from the locomotive. Upgraded gas-turbine locomotive was designated as "GT1h-001" (Fig. 4).

Test results of the gas-turbine locomotive have confirmed high economic efficiency of the innovative project. The costs of fuel (liquefied natural gas) are 56% lower comparing with diesel fuel; life-cycle costs are 19.4% lower compared to those for diesel locomotives 2TE116.

One gas-turbine locomotive replaces four sections of main-line diesel locomotives

2TE116. In the fact, the gas-turbine locomotive GT1h-001 has become the most environmentally friendly of all the locomotives operating hydrocarbon fuel: it has met (with a high reserve) the European norms that apply to locomotives since 2012.

The design of gas-turbine locomotive comprises 44 patents including 21 international patents.

Since 2013, the under-control operation of gas-turbine locomotive has been organized at the railway section Egorshino – Serov (Sverdlovsk railway) in accordance with decision of Russian Railways. Fueling the gas-turbine locomotive with liquefied natural gas is carried out by "Gazprom Transgas Ekaterinburg" LLC at GDS-4, Apparalnaya station.

In 2013–2015, the gas-turbine locomotive GT1h-001 has carried out more than 200 trips at the head end of the train at Sverdlovsk Railway.

Work accomplished is more than 200 million tonnes·km gross. Running in the head end of the train is 43,000km. The maximum weight of the train is 8,927 tonnes.

Performance testing of the gas-turbine locomotive GT1h-001 at the railway section Serov-Sortirovochniy – Egorshino (Sverdlovsk Railway) has confirmed:

- capability of using the gas-turbine locomotive for driving heavy freight trains (weight of 6,000 – 9,000 tonnes),
- working capacity of the gas-turbine locomotive's equipment under vibrating condition of the locomotive and low ambient temperatures,
- working capacity of the control algorithms under heavy train driving conditions,
- effectiveness of selected algorithms for power block control with reduction of the gas-turbine engine speed at idle from 5,400 RPM to 3,000 RPM. This has allowed to reduce fuel consumption by 15-20%, and
- effectiveness of fueling the gas-turbine locomotive at the GDS-4 complex infrastructure.

Taking into account the positive results of testing the first gas-turbine locomotive in 2012, Russian Railways JSC has commissioned VNIKTI to develop design documentation for manufacturing prototypes of locomotives operating on liquefied natural gas.

In 2014, a second (production) prototype of the main-line two-section gas-turbine locomotive GT1h-002 based on the underframe



Fig. 5. Gas-turbine locomotive GT1h-002 based on the underframe of diesel locomotives TEM7A

of diesel locomotives TEM7A was produced at the Ludinovskiy diesel locomotive plant (Fig. 5).

The layout of the equipment in the gas-turbine locomotive GT1h-002 is shown in Figure 6.

Gas-turbine locomotive is equipped with high-power gas-turbine engine (8,500 kW). Gas-turbine locomotive GT1h-002 has 16 traction axes (as opposed to GT1h-001) to enhance traction properties and to use power in case of complicated track profile. Modular control cabin was created on the basis of cabin of serial electric locomotives 2ES6 having a positive operating experience in conditions of the Ural region.

To improve the fire safety, the cryogenic and gas equipment was placed more efficiently and arranged in isolated compartments. To ensure safety, the cryogenic tank was placed in an open area in the center of the booster section. To increase the GT1h-002 gas-turbine locomotive's running on one fueling, the servicing LNG reserve is 20 tonnes instead of 17 tonnes on the gas-turbine locomotive GT1h-001. This allows running up to 1,000 km. Open arrangement of the tank simplifies the procedure of preparation for locomotive's start-up and provides more secure and convenient access to the shut-off valves. Technical parameters of the gas-turbine locomotive GT1h-002 are shown in Table 2.

Power transmission to the booster section is carried out by means of busduct. This allows to reduce weight of the components of electrical power equipment and save space inside the body.

Rechargeable traction battery was arranged in a separate container of modular design placed in an open space between bogies.

The auxiliary converter PSN-GTV which was developed and produced by JSC "R&D

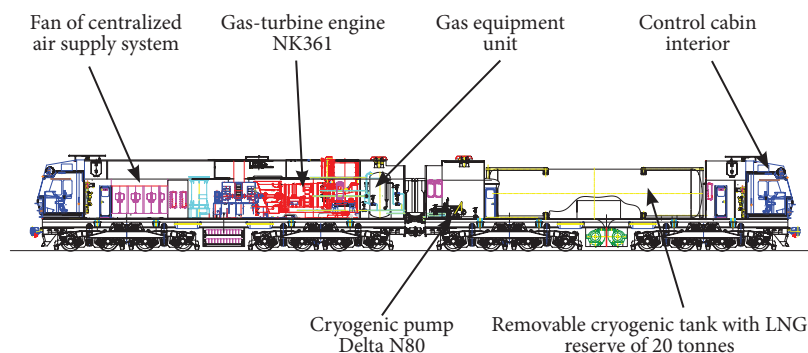

Fig. 6. Layout of the equipment in the gas-turbine locomotive GT1h-002

Table 2. Specifications for GT1h-002

Parameters	Value
Power, kW	8,500
Number of traction axes	16
Tractive effort of long-time mode, kN	700
Fuel margin, tonnes	20
Cruising range without refueling, km	1,000

Automation" (city of Ekaterinburg) distributes and controls energy flows for auxiliary needs, has a double reservation and, accordingly, increased reliability.

A new safety system BLOK instead of KLUB-U was implemented in the gas-turbine locomotive GT1h-002 as opposed to GT1h-001.

Also the RUTP system (distributed control of the train brakes) developed and manufactured by MTZ Transmash was implemented the locomotive for the first time. This system allows to control the train brakes more effectively ensuring a smooth braking and release of the brakes, which is important while driving the trains of increased weight and length.

After commissioning, on December 13, 2014 the gas-turbine locomotive GT1h-002 has driven an experimental freight train of 9,000 tonnes weight through the railway section Ribnoye – Orekhovo-Zuyevo of the Moscow railway. After the end of stage of preliminary and acceptance tests, under-control operation of the gas-turbine locomotive GT1h-002 has been carried out at the Sverdlovsk railway since November 2015.

In accordance with the agreement signed between Russian Railways and Sinara Group, it is expected to produce 40 main-line gas-turbine locomotives of the new generation. (S)



## The world's first gas reciprocating shunter: TEM19



**Evgeny Vasyukov,**  
Design Director of Bryansk Engineering Plant (BMZ JSC)

With Russian Railways (RZD) aiming to replace 30% of the diesel fuel consumed by its locomotives with natural gas by 2030, development of the gas reciprocating shunting locomotive TEM19 (Fig. 1) was launched in 2013. The locomotive is designed to reduce transportation costs as well as improve traffic efficiency and mitigate railway transport's impact on the environment. The project was a joint effort of Russian Railways (RZD) (more specifically RZD's engineering institute VNIKTI) and engineers from Bryansk Engineering Plant (BMZ).

### Background of Locomotive Development

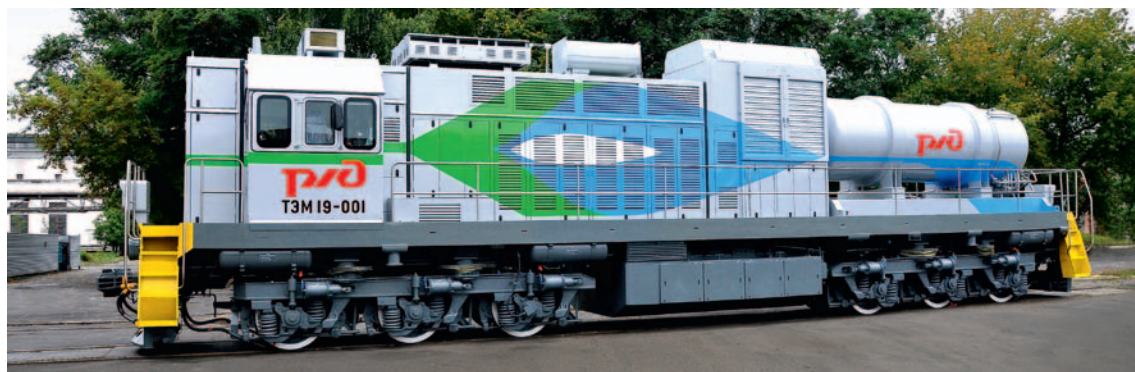

**Fig. 1.** Gas reciprocating locomotive TEM19

The national subprogram<sup>1</sup> to reduce railway transport's consumption of diesel, which is part of Russian Transport System Development Program, was launched in 2015. The objective is the gradual replacement of rolling stock, which use traditional fuels, with NGV-based traction vehicles.

BMZ already has some experience of developing and manufacturing gas-powered shunting locomotives. Two class TEM18G locomotives (No 001 and 002) were developed and built between 1997 and 1998, and in October 2000 were delivered to Khovrino Station, Oktyabrskaya Railroad for field trials. Both units were based on the TEM18 diesel locomotive platform.

The major difference between the new TEM19 gas reciprocating locomotive and the TEM18G is that the new unit relies solely on natural gas for operation and does not require the addition of diesel fuel. This results in significant cost savings through both the use of cheaper gas fuel and the ability to stop the engine for long periods during the winter due to the use of antifreeze mixture as a cooling agent. Moreover, hazardous exhaust emissions like NOx are 96% lower and the gas engine emits 91% less carbon dioxide and 95% less hydrocarbons.

With compressed natural gas the TEM18G's primary fuel, diesel oil is used only as an ignition primer. Natural gas is compressed

<sup>1</sup> Within the national program "Introduction of gas-fuel vehicles integrating stand-alone subprograms for highway, sea, inland water, air vehicles and special purpose equipment".



to 20MPa (200kgf/cm<sup>2</sup>) and stored in the gas locomotive's storage unit which comprises 17 vessels, with a single vessel having capacity for 200dm<sup>3</sup>. Compressed gas is fed from the storage unit to the gas diesel through first, second and third stage reducing valves and three gas heaters.

Gas fuel delivery is engaged automatically at notch four and further nodes are activated during operations under load. As per Railway Research Institute (VNIIZhT JSC), replacement of diesel with natural gas has reached 45-50%. The natural gas allowances can support locomotive operation for 2.5 days.

The TEM19 uses a 880kW (1,197hp) natural gas reciprocating power unit and ac-dc electric transmission is designed for shunting operations on 1,520mm-gauge tracks at temperatures between 40°C and -50°C as per GOST 16350 and GOST 15150 (U class, 1<sup>st</sup> category) standards. The locomotive's technical parameters are shown in Table 1.

**Table 1.** Technical Parameters of TEM19

Engine Output	880kW
Wheel Arrangement	CoCo
Service Weight (with 2/3 of fuel and sand onboard)	126 tonnes
Axle Load	206kN
Tractive Power	
– starting	100kN
– design	12kN
Min. Curve Radius	80m
Capacity	
– fuel*	3,500kg
– sand	400kg
Gage under GOST 9238	1-T
Locomotive Sizes	
– length over coupler pulling faces	20,000mm
– max width	3,120mm
– cab height	4,430mm

\* from TEM19-002 onwards, fuel capacity will be 5,300kg

## Design Features

TEM19 was developed on the basis of TEM18DM undercarriage, a well proven diesel locomotive. A modular approach to the locomotive's layout greatly improves maintenance and repair operations, with the body comprising the following modules: driver's cab, cryogenic unit with gas conditioning and supply system; gas engine-generator set; cooling tower and brake equipment; hardware cabinet; and a auxiliary equipment module which is located under the locomotive frame.

It is important to note that more than 90% of the components used in locomotive are Russian. After an import substitution exercise, the locomotive may be assembled completely from domestically-sourced components.

The TEM19's driver's cab meets the requirements of Sanitary Rules SP 2.5.1336 and is equipped with an HVAC system. Safe

operation is ensured through the use of direct locomotive and automatic air train brakes, and a hand parking brake as well as an automatic gas and fire detection system. In addition, the locomotive features a safety system with a motion parameters recording function, and integrates cab signaling ALSN-1D with data collection and recording system KPD-3PV, as well as a telemechanic driver vigilance system. Moreover, the driver has access to a dual-band railway radio (medium-frequency and VHF bands) while a multi-tasking microprocessor control and monitoring system displays information on the control panel display in the driver's cab.

The locomotive is equipped with gas fuel flow metering system, a self-braking system in case of detachment, a sensor to identify a brake pipe disconnection, as well as other systems required under applicable standards.

## Engine

The key objectives of the locomotive's development process were to provide normal engine operation using gas, with

low rotating speeds and stable operation and some cylinders able to switch off when idle. The locomotive pioneers the

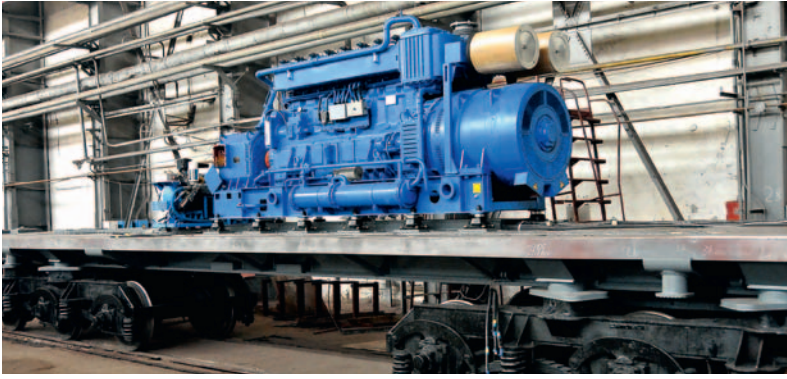

Fig. 3. Engine installed on locomotive underframe. Assembly process

integration of the gas-reciprocating engine with an antechamber torch ignition and in-line cylinder arrangement produced by Volzhski Diesel, as a part of GDG800Tgas engine-generator set (Fig. 3). The engine's output depends on gear shifting, while the engine's varying duty allows operation at 100-1,000rpm to offer additional fuel savings.

In addition, an external power source is available and utilized to preheat the gas reciprocating engine in case the locomotive cools while in standby mode.

### Fuel Storage & Refueling

Another challenge is to store fuel on the locomotive. The solution deployed consists of a front-mounted detachable cryogenic storage tank which carries sufficient liquefied natural gas to support five days of operation, or eight shifts without refueling. The cryogenic tank (Dewar vessel) may store gas for 40 days thus allowing simultaneous refilling of six replacement cartridge-vessels from a LNG carrier. The tank

has a fastening system similar to that used by a standard 20-foot container, which enables the dismantling, remounting and filling of an empty tank from the locomotive in 20 minutes.

The cryogenic tank is straightforward to replace: one needs only to disconnect the gas supply pipeline and then reinstall the vessel. This is a Russian engineering solution and the application of detachable fuel tanks installed on

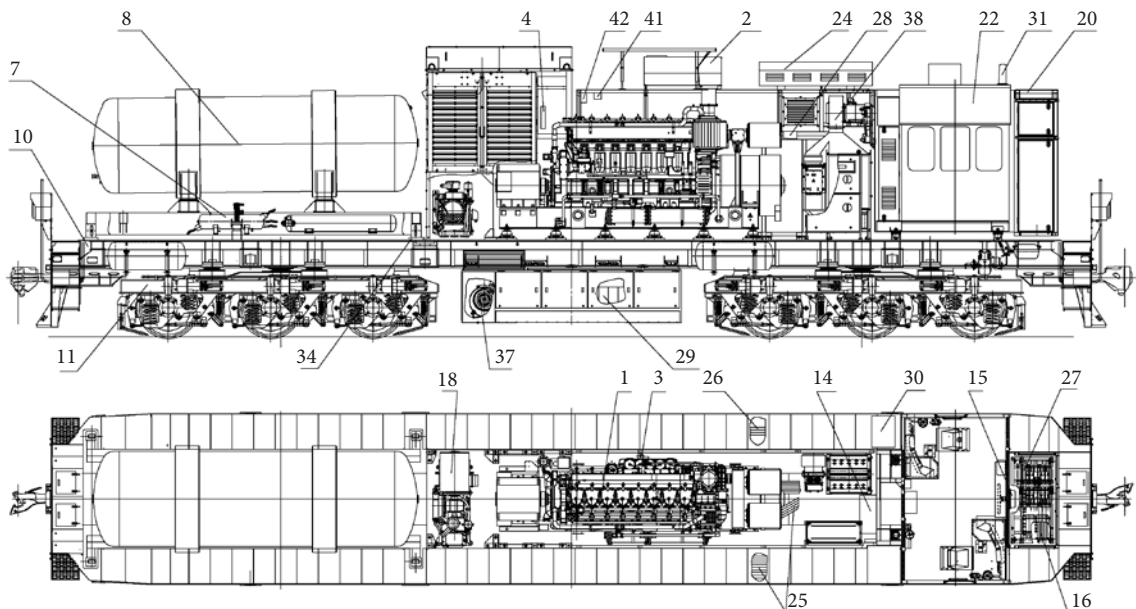

- |                             |                                       |   |
|-----------------------------|---------------------------------------|---|
| 1 – engine generator set    | 16 – auxiliary equipment air pipeline | 30 – continuous cab signaling (ALSN-1D), data collection and recording system (KPD-3PV) |
| 2 – silencer                | 18 – compressor unit                  | 31 – railway radio RVS-1  |
| 3 – crankcase gases drying  | 20 – body                             | 34 – fuel weight monitoring system  |
| 4 – cooling system          | 22 – cab                              | 37 – traction motor fans  |
| 7 – gas conditioning system | 24 – set of resistors                 | 38 – rectifiers fan   |
| 8 – cryogenic tank          | 25 – power equipment                  | 41 – fire detection system  |
| 10 – locomotive underframe  | 26 – auxiliary circuits               | 42 – gas detector   |
| 11 – bogie                  | 27 – HV cabinet                       |   |
| 14 – braking system         | 28 – lightning                        |   |
| 15 – hand brake             | 29 – battery                          |   |

Fig. 4. Layout of TEM19

an open platform improves locomotive servicing time, reduces infrastructure costs, and enhances safety during operation and maintenance.

Refilling of the tank is possible directly from a LNG carrier or gas-filling station and involves the following process: a special fill valve is fitted on the cryogenic vessel module to connect the gas-distribution station or LNG carrier supply line. Another valve diverts the liquefied gas, which is supplied because the empty tank's temperature is higher than the temperature of the supplied gas. Vaporizing gas cools down the tank and flows back in gaseous state, thus there is no fuel losses during the refilling process. As soon as the temperature of the vessel is equal to the gas temperature, it is refilled with liquefied gas. In the top of the tank there is a so-called gas pad that takes up 5-7% of the tank's volume.

The fluid gas receiver and heat exchanger are located under the cryogenic tank in order to convert the liquid gas into gaseous state and feed it to the gas reciprocating engine (Fig. 4).

In order to increase power utilization, the following design solutions have been applied in the TEM19: a closed gas-engine cooling system with coolant forcing circulation; asynchronous drive of cooling tower blower motors, electrical machines and units; and a screw compressor package with pressed air handling.

The design of traction motors' radial cooling fans, and traction and auxiliary rectifiers incorporates an asynchronous motor drive. The locomotive also has a dc motor-driven modular compressor unit with rotary-screw compressor AKRV3.2-10-1000 with a capacity of 3.2 m<sup>3</sup>/min.

## Bogies with rolling motor-axle bearings

The locomotive utilizes two three-axle bogies which integrate with the wheel-motor sub-assemblies (Fig. 5). Rolling axle bearings are used in order to reduce operating costs and have been proven efficient in the locomotive arrangement. For instance, the maximum heating of rolling axle bearings has not exceeded 53°C and no lubricant blowouts from gears and rolling

axle bearings have been reported from trial operations with five TEM18DM locomotives. All findings of the Buksol grease compositional analysis and solids control were compliant with the Grease Technical Specifications. Moreover, a wide range testing and vibration monitoring checks have demonstrated the good operating condition of rolling axle bearings.

## Prospects

During September 2015's Expo 1520 railway exhibition, BMZ's TEM19 received a Certificate of Conformity, which confirms that the locomotive meets the requirements of Customs Union Technical Regulations 'On Railway Rolling Stock Safety' (TR TS 001/2011). This document provides the gas locomotive with official notice to operate on RZD tracks, and the first TEM19 locomotive was delivered to Sverdlovsk Railway on the November 10 2015. According to RZD's procurement plan, Sverdlovsk Railway will procure 50 gas-reciprocating locomotives up to 2025.

Delivery of the next gas reciprocating locomotive to RZD is currently at the pre-contractual stage with completion expected this year. It is anticipated that depending on loading, gas reciprocating locomotives will double efficiency, with refueling required only once every 14 shifts. 

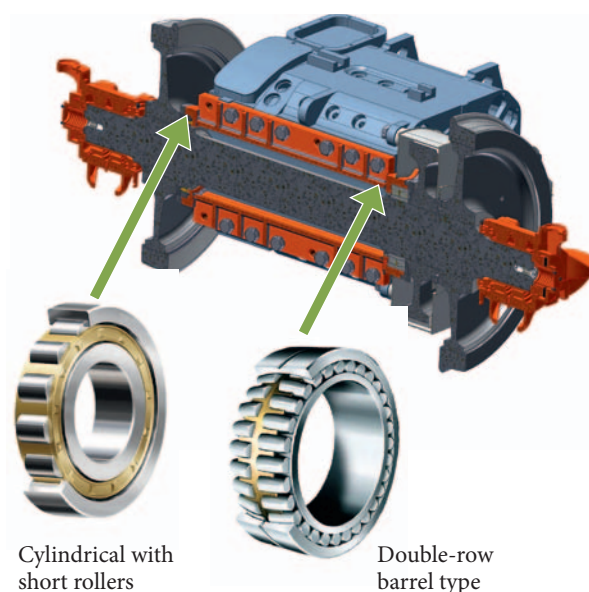

Fig. 5. Cross-section of standard wheelset with rolling bearings



# Technical and design features of the EG2Tv 'Ivolga' EMUs



**Sergey Orlov,**

Deputy Technical Director of Tver Carriage Works, EG2Tv (Ivolga) Project Manager

Transmashholding has developed a new universal basic platform of Russian EMU trains (including urban, suburban and regional trains). First two prototypes of the product line representing urban version (EG2Tv, 'Ivolga') were produced in 2015 and successfully passed all acceptance and certification tests. The trains have been developed and produced by the engineers and technicians of Tver Carriage Works (TVZ, Transmashholding company). It is expected that EG2Tv production (see Fig. 1) will also take place at this plant.

The EMU is designed and produced in accordance with the Russian regulations in force and fully meets the requirements of Customs Union Technical Regulations. The carbody is made of stainless steel ensuring its

service life before overhaul for at least 40 years. State-of-the-art engineering solutions ensuring high safety, reliability and comfort of rolling stock have been implemented for the new basic platform.

## Safety & Reliability

The required fire safety level is ensured by the following engineering solutions introduced into cars:

- modern non-combustible and low-combustible materials for passenger saloon lining and interiors;
- fire alarm and extinguishing system;

- alongside with ordinary passenger doors, every car has four additional emergency exits through special windows allowing passengers to get out of the car by fly rope in case of emergency.

In case of train crash, the safety of passengers and train crew is ensured by train passive safety system, and additional crash elements installed on terminal cars and coupling. Such collision safety arrangements became obligatory for all rolling stock after the introduction of the Customs Union Technical Regulations in 2014.

The train is also equipped with domestic certified telecommunication system and safety system (BLOCK unit) which ensures required safe traffic operation conditions.

Moreover, passenger safety is achieved by means of video surveillance system providing observability of the whole passenger area with almost no blind areas. Information is displayed at driver's VDU, recorded and stored for 7 days for further review, processing and analysis.

In the process of 'Ivolga' creation a special focus was on reliability and efficiency of braking. The train has a microprocessor-based combined braking system using electrodynamic



Fig. 1. EG2Tv on Trials



and electropneumatic braking. Electrodynamic brake is primarily used for service braking. Friction braking is achieved by application of electropneumatic brake system.

The driver initiates a braking command via brake valve handle (braking controller). Brake control system allocates braking efforts among available systems with priority given to the electrodynamic brake. If electrodynamic braking effort is not sufficient, the control system additionally actuates friction disk brake. Required braking pressure is computed by brake control software.

In order to prevent train rolling-down on gradient tracks, there is an automatic parking brake which holds the train under maximum load condition at gradients up to 30%. The main every car's brake control functions are the following:

- electronic processing of all brake signals and setting relevant brake effort tasks for each brake system,
- management of WSP,
- generation of necessary pressure in air brake cylinder depending on train load condition and braking effort, and
- parking brake control.

It is important to note that logic of brake system program control is autonomous and independent of other systems of the train. Moreover, brake add-on reliability is provided through a modern compressed air preparation

solution applied in train pneumatic system. Fresh air is fed in oil-free piston compressor that generates required pressure. Then the air flow is supplied in a double-chamber dryer that removes excess moisture in order to protect brake system instruments and units which is important during cold seasons when excess moisture under low temperatures may cause valve freezing or air pipeline damage. As a result of air preparation, relative humidity of compressed air supplied by the compressor into brake and pneumatic systems is less than 35%, air is free from oil, ensuring reliable operation of brake system over a wide temperature range. Moreover, this does not require secondary oil filter and consequently any disposal of oil and dirty filter materials (a very important aspect for environment safety and reduction of operating costs).

Every wheel of the train has a brake disk (fixed directly on wheel side surface). Forces from a brake pad to wheel disk are transferred through brake jaws, half of which is fitted with spring-loaded accumulators functioning as parking brake. Due to their efficiency, reliability and operating economy, disk brakes are today beyond any competition. It is the first time when they are used at domestic EMUs.

All in all, multilevel combined braking system together with air preparation system and disk brakes ensure desired deceleration of the train under any conditions and as a result guarantee passengers safety.

## Adaptability

Interior layout design of 'Ivolga' trains is based on modularity approach (Fig. 2a, b). Modular layout principles provide fast customization of the train parameters in accordance with different train operators' needs (the train may be used for urban traffic, for city-airport transfers, etc.).

If a customer has any individual requirements, car interior may be easily reshaped without global reassembly: seating layout and number of seats, luggage racks, winding machines, bike strappings, etc.

The new train may be modified, depending on application and operating region, to a trainset consisting of 4 to 14 cars with various configurations of leading, motor and trailer (non-motor) cars with different acceleration performances and maximum speed up to 160 km per hour.

The materials and components used for 'Ivolga' make its operation possible at ambient temperatures from +40 to -40 °C. Passenger comfort is ensured due to relevant carbody thermal insulation, heating and conditioning systems.

The train is designed for the 1520 track but in future may be easily adapted to the 1435 gage without any changes in core systems (except for engineering modification of the current bogie used in the train).

The driver's cab represents a complete module. The module has been designed in such a way that cab nose shape can be changed depending on train application and customer requirements. The train equipment installed on roof and underframe is closed with aerodynamic skirts.

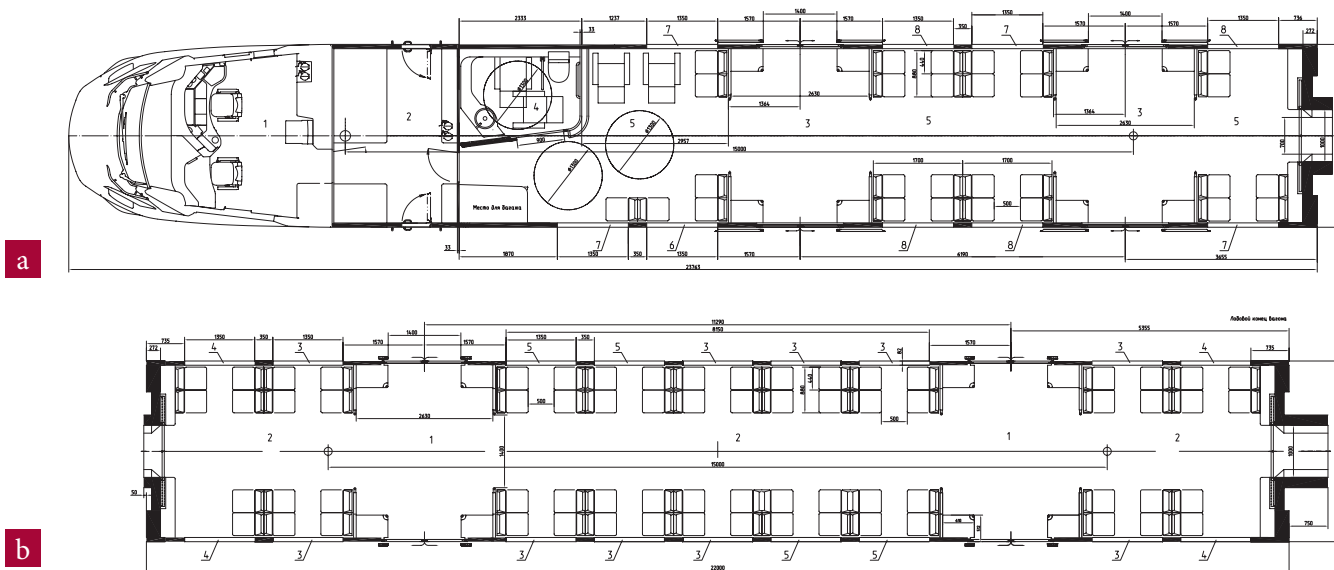

Fig. 2a, b. Layout of Leading Car (a) and Trailer (non-motor) Car (b)

## Operating Aspects

Asynchronous traction motor drive and regenerative brake used in the train significantly improve its reliability and operating economy (power consumption is reduced by 15-20% vs collector-type motor drive), reduce maintenance burden and its frequency. The above solutions together reduce operating costs.

Table 1. EG2Tv Basic Parameters

Manufacture year	2015
Service life	40 years
Design speed	up to 160 km/h
Car length	
Leading	23,800 mm
Intermediate	22,800 mm
Car width	3,480 mm
EMU length	116 m*
Door opening width	1,400 mm
Number of car in basic configuration train	5
Train configuration options	any from 4 to 14 cars
Multiple unit operation	for two coupled trains
Average acceleration to 60 km/h	0.87 m/c2
Train weight	263 t*
Carbody material	SS
Type of traction motor	asynchronous
Continuous capacity for basic configuration train	3,600 kW (300x12)
Max passenger capacity	1,663 pass*
Specific capacity per 1 meter	14.1 passengers
Empty weight per passenger at max load	0.160

\* for basic configuration (5-car trainset)

Economic efficiency of this train relies on a number of factors:

- Energy-saving lighting based on LED lamps (10 times lower power consumption vs traditional incandescent lamps, 25 – 30 times cutting maintenance costs),
- Optimal operating algorithm of climate control units with automatic temperature control and fresh air flow supply in accordance with car occupancy, which is defined through measurement of exhaled carbon dioxide (special sensors installed in passenger compartments). HVAC system is switched on only if necessary, thus 2-3 times reducing power consumption,
- Selective doors opening reduces door operators wear-out and saves energy,
- Increase of runs between repairs requiring cars jacking, and
- Reduced time and labor necessary for saloon cleaning due to new design that has no hard-to-reach areas and common saloon space without entrance cubicles. Ease of cleaning is also attributable to seat supports design.

One of the EMU advantages is high mobility during passengers entraining / detraining and increased traffic flow. Each car has two 1,400mm sliding plug passenger doors, the doors are located along the train equally, contributing into reduction of train boarding/alighting time.



Fig. 3. EG2Tv Motor Bogie

## Bogie

Motor bogie (see Fig. 3) rests on two axles and is suspended by springs. Its suspension has two levels – spring primary suspension and pneumatic secondary suspension. Bogie frame is functioning as load carrying member. Almost all equipment responsible for bogie operation is either mounted on or supported by the bogie frame.

Wheelsets comprise monoblock wheels and brake disks fixed on wheels. Wheelset has axle boxes with roller bearings. Each axle has a gear motor assembly responsible for torque transmission from asynchronous traction motor through coupling and gear to the wheelset.

The primary axle-box suspension includes helical springs, rubber-metal supports and hydraulic dampers. Wheelsets are connected to the bogie frame via lever-type axle boxes and silent blocks that serve to transfer efforts generated during train motion to the bogie frame.

The bolster suspension uses pneumatic springs installed on bogie frame. Constant distance between carbody and top of rail is maintained irrespective of a car load by the pneumatic suspension control system through adjustment of air pressure of pneumatic springs.

Vertical and horizontal hydraulic dampers are used for separate suppression of carbody and bogie vertical and horizontal oscillations.

Safety ropes between bogie and carbody are used in order to improve safety, and in case of failure in pneumatic suspension control system.

Vertical stresses from carbody are transferred to the bogie frame through air springs. Further, the loads are delivered from the bogie frame to the wheelsets via axle-box springs and axle-box housing assembly. In case of carbody vertical movements, the axle-box travel is limited by elastic contraction of silent blocks and axle box springs.

## Passenger Comfort

Exterior and interior train design is based on modern anti-vandal materials harmless for passengers: FRP lining panels, fire-resistant covering cloth for seats, environmentally-friendly floor covering, etc.

Better riding comfort is achieved through the use of pneumatic springs in the bogies ensure car floor leveling irrespective of its load opposite to unlike coil springs. For instance, 'Ivolga' riding comfort index does not exceed 3.0 (vs max value of 3.25 per specification).

Depending on the car load, the system automatically determines necessary level of pressure in pneumatic springs and increases or decreases it when it is appropriate.

The train is equipped with automatic climate control system. The system provides ventilation of EMU passenger saloons and driver's cab integrating deep cleaning of intake and recirculation air and its ultraviolet sterilization. HVAC units maintain internal car temperatures between +14 °C and +18 °C in winter and not more than +28 °C during summer, under ambient temperature conditions from -40°C to +40°C. Moreover, the entrance doors have air curtains also helping to keep temperature comfortable at any time during the year.

Selective door opening system allows opening of only those doors that are necessary at the moment. The doors are equipped with anti-





Fig. 4. Passenger Compartment



Fig. 5. Place for Wheelchair Passenger

pinch sensors that prevent passengers to be trapped between door leaves.

Floor has darker coloring in entrance/exit zones, thus making it easier for passengers to find their way.

All cars have wireless internet access.

Carefully designed layout of overhead and vertical handholds provides passenger safety both for high and low load scenarios (see Fig. 4).

When creating the train, the engineers paid a great deal of attention to the solutions ensuring particular comfort of travel and easy circulation for passengers with disabilities, like wheelchair passengers:

- wide doors and pass-through gangways with the same floor level as in passenger saloons;
- staff call button located in the boarding area;
- terminal car doors are equipped with wheelchair ramps;



Fig. 6. WC room

- space to park and secure a wheelchair (see Fig. 5);
- accessible toilet rooms (see Fig. 6).

Moreover, all relevant information has braille stickers for visually-challenged passengers.

## Local Content

Unlike its foreign competitors available in domestic market including those assembled in Russia, the EMU family in general, and its first urban member 'Ivolga' in particular, is made-in-Russia product, i.e. it has been developed by Russian engineers and assembled to a large extent from components manufactured by Russian suppliers. The key focus area during implementation of this innovative project was maximum local content in the production of the train itself and its components. The key ones are coupler, gangways, traction equipment, and brakes. High local content has been achieved as early as during the production of the first

prototype five-car train. The local content of the train will be further increased and finally shall overpass 80%.

With its technical, operating and end-use properties, 'Ivolga' train is equal to the best foreign competitors, and in some ways (like train composition flexibility, acceleration to 60km/h, higher passenger capacity at shorter car length, etc) is better. And, crucially, it is significantly cheaper than its foreign competitors.

Two 5-car trains have been manufactured so far. They will start their trial runs on tracks of transportation hub. 🇷🇺



## Underground Cars Refurbishment for Budapest



**Vladimir Dzyuban,**  
Director, Design & Development Center of Metrowagonmash JSC

In July 2015, Metrowagonmash (an entity of Transmashholding) was awarded a contract to overhaul 222 metro cars (37 6-car metro trains) for Budapest Metro. Under the contract, the Russian company would perform in-depth refurbishment of the trains. The first renovated train was sent to Budapest in the first fortnight of May.



**Fig. 1.** 81-717/714 metro car from Budapest to be modernized

At the tender stage, Metrowagonmash (MWM) has submitted its bid alongside with Alstom Transport, Škoda Transportation,

CAF, an Estonian company Skinest Rail, and companies from Romania and Hungary. The contract scope covers heavy refurbishment of 185 81-717/714 cars, 10 81-717/714-2M cars and 27 Ev3 cars from 2016 through 2018. These cars were developed in the 60-70s by Mytishchi Machine-building Factory, one of world's largest metro cars manufacturers that was transformed into Metrowagonmash in 1992. Cars deliveries to Budapest started in the 70s. Due to expired service life and high wear of the cars (Fig. 1), the Budapest Transportation Corporation (BKV Zrt.), suburban railway operator, decided to upgrade the cars that would increase their lifespan by 25 years.

### Key Points of Modernization

The first 81-717/714 metro train that arrived to Metrowagonmash for the refurbishment was in service 1986 to 2016. The overall condition of the train could be characterized as satisfactory; however outside the train there were numerous graffiti, paint peels and rust. MWM staff performed extensive refurbishment that covered virtually all car parts (Fig. 2).

Metrowagonmash has ISO 14001:2004 compliance certificate under Euro-Standard Voluntary Certification System issued by the Federal Agency on Technical Regulating and Metrology. The certification confirms that the Ecology Management System is integrated at the level of metro product development, manufacturing, delivery and aftersale services of the company. The company develops and deploys

documents that enhance Ecology Management System according to ISO 14001 requirements.

#### Body and Interior of the car

Old paint coating was removed and the car bodies were repainted with new high quality polyurethane coating supplied by the leading foreign paint manufacturers. The renovated cars were also equipped with roofs without protruding air intakes (which were used in previous 81-717/714 metro cars operated in Budapest). The roofs have grids feeding the ceiling-mounted ventilation system. This new changes would ensure comfortable travel conditions for passengers both during train motion and at the stations.

Car underframe center girders and bolsters were reinforced. The primary structural



Fig. 2. 81-717/714 metro cars after renovation

elements of carbodies were replaced leading to extension of carbody lifespan by 30 years.

Cars interior also required significant refurbishment efforts. The cars received electric windshield wipers and electronic route table visible at any lighting level. The ventilation system of the upgraded leading cars has 7 ventilation units, and there are 8 units in the intermediate cars. The system is capable to supply 7,000-8,000 m<sup>3</sup>/h of air corresponding to minimum 20 m<sup>3</sup>/h per passenger even under maximum loading of the car. In case of train stop in a tunnel and high-voltage release, the system supplied from the batteries would continue its operation for one hour.

Interior trimming with FRP panels is complies with DIN 5510 Preventive fire protection in railway vehicles standard. The passenger compartments are equipped with new half-rigid vandal-proof sitting benches that fully meet up-to-date ergonomic requirements. Sitting layout allows automated cleaning. Figure 3 shows passenger compartment interior before and after refurbishment.

Internal lighting layout is designed as a light line with fluorescent tubes. Passenger handholds are made of polished stainless steel offering strength without sacrificing aesthetic characteristics.



The entrance sliding doors are motor-operated. Unlike the old ones had constant-pressure compressed air cylinders, the refurbished doors feature state-of-the-art anti-pinch system with slowing-down of doors at the end of closing that minimizes the possibility of passenger injuries and reduces noise level during doors opening and closing.

### Nose and Driver's Cab

State-of-the-art fire-resistant fiber glass masks were installed on 30-cm frame of the refurbished leading cars. New noses also fitted with a fold-out emergency escape ladder. Moreover, the materials and technologies used for new car nose production reduce thermal conductivity and improve sound-proofing; the noise level generated during car motion in traction mode on a reference track section with ground rails does not exceed 75 dBA. The car nose is equipped with four LED spotlights with advanced light performance.

The driver's cab space was increased by 300 mm thus ensuring better operational comfort for the driver. The cab was equipped with a primary control desk integrating the main housing and side posts hosting control panels and display consoles with operating controls and information displays, as well as other controls and equipment that require in-process control of the driver during train operation. All controllers and information displays of the driver desk are organized according to their function. Main controllers that require continued involvement of the driver are located in the central area of the desk. (Fig. 4). Moreover, the driver desk integrates the control unit of the digital information complex developed by domestic companies. The master controller is responsible for train traction and braking operating modes.



Fig. 3. Interior of 81-717/714 car: a) before renovation; b) after renovation



Fig. 4. Driver's cab: a) before renovation; b) after renovation

It is located on the primary control desk and has six notches. Dead man button is mounted in the controller handle (under left thumb). The driver comfort is ensured through ceiling conditioner, sliding vent panes, seat with vibration absorbing system, fridge, and heater for a water can. The cab is lined with conventional materials.

### CCTV and Communication

CCTV systems are installed in all the metro cars. Video is transmitted from two cameras located in both car ends, and from two passenger-driver emergency communication units nearby passenger doors thus allowing driver's monitoring situation in passenger compartments.

The trains also have a communication channel to transfer information live to the Metro Situation Center. Moreover, the cars are equipped with Wi-Fi.

### Power Equipment

Asynchronous motors ensuring recuperation of at least 35% of energy are used in the upgraded cars bogies instead of outdated DC motors

with carbon brush assemblies being a source of graphite dust (one of the most hazardous substance for human respiratory system).

Wheel flange lubricators using liquid lubricants were replaced with solid wheel flange lubricators with dry solid sticks. Mechanical brakes use modern asbestos-free brake shoes with long lifetime, high wear resistance, better ecological performance, and enhanced frictional behavior.

New equipment and appliances reduce effective current consumption for traction by 9% (power recovery not included), decrease continuous and maximum current of railway substation, allow across-the-line start of the traction motors, smooth acceleration and speed change, and improve skid and slipping resistance. The scope of traction drive items was also reduced leading to 25% weight reduction of traction system. Moreover, equipment diagnostics and reprogramming functions were added. Across-the-line start and energy recovery function allow significant reduction of car heat demand alongside with saving up to 50% traction energy demand at all speeds.

## Next Steps

In general, the first train refurbishment at Metrowagonmash facilities required 4 and a half months (from January to May). As a result, after refurbishment, the rolling stock operator's maintenance and repair costs are to fall by minimum 20%, and energy consumption shall decrease due to integration of energy recovery.

It is expected that the first renovated train would shortly start tests in Hungarian Metro, and would receive a certificate by the beginning of

January next year. Thereafter, Metrowagonmash is planning to deliver the customer two 6-car metro trains per month. The last refurbished train is expected to arrive to Budapest by August 2018 at the latest.

The warranty period of the refurbished cars will last for 3 years. Within the warranty period, MWM remains fully responsible for the car breakdowns attributable to the manufacturer. The company will also support all supplies of spare parts under the contract. 



# Locomotive diesel engines in Russia: current condition and prospects



**Georgiy Zobov,**  
Head of Railway Industry Research Department,  
Institute of Natural Monopolies Research (IPEM)

The Russian diesel locomotive engine market is going through a major transformation. With a fleet of 16,000 units, there is annual demand for 850 engines which are provided by three main Russian suppliers. However, with increasing demand for better performing engines, these companies are entering into cooperative agreements with international partners in order to meet these needs.

## Domestic production of diesel engines

Historically, Russia's key diesel engine manufacturers have been Kolomensky zavod, Penzadieselmash and Ural Diesel Engine Plant (UDMZ). Traditionally these companies supplied the "1520 space" covering the Soviet Union but also exported products to Eastern Europe, Latin America, North Africa and Asia. Each company has their own engineering school as well as the competencies to create new technical equipment.

The largest consumer of medium-speed diesel engines in Russia is Russian Railways (RZD), which currently operates just over 10,000 diesel engines. According to the data from the Scientific and Research and Design and Technological Institute for rolling stock (VNIKTI), RZD requires 500-700 diesel engines annually, encompassing units with a power range of 300-1800kW for shunting operations and 2000-4500kW for main line diesel locomotives.

Currently 15% of the total main line diesel locomotives operated in Russia are equipped with 2D100 and 10D100 two-stroke diesel engines, which

were built at the Kharkov Transport Engineering Plant. Production at the site began in 1947, and today work focuses on supplying replacements for life-expired D49 (ChN26/26) diesel engines.

A number of D49 diesel engines (Figure 1) with a power range from 585 to 4400kW were built in the early 1970s at the Kolomensky Zavod. Today, D49 engines are the foundation of RZD's diesel locomotive fleet and perform virtually all passenger and freight transport. Other diesel engines in use include the ChN31.8/33, which is built by Penzadieselmash, ChN21/21 type (UDMZ), ChN14/14 type (Avtodiesel), and ChN18/20 type (Zvezda) (Fig. 2).

Unfortunately, the technical parameters of a number of the locomotive diesel engines in service do not fully meet RZD's requirements for the future, particularly in terms of efficiency. In light of this and increasing demand for medium-speed engines for locomotives (Fig. 3), new types of diesel engines have been actively developed since the mid 2000s.



Fig. 1. D49 diesel engine in the locomotive-repair depot.

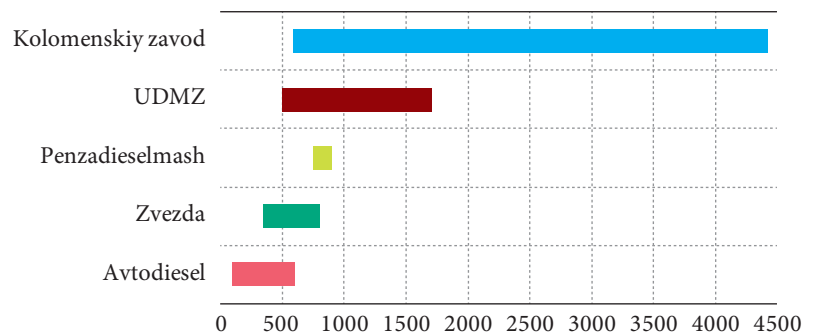

Fig. 2. Power range of locomotive diesel engines produced by Russian manufacturers [kW]



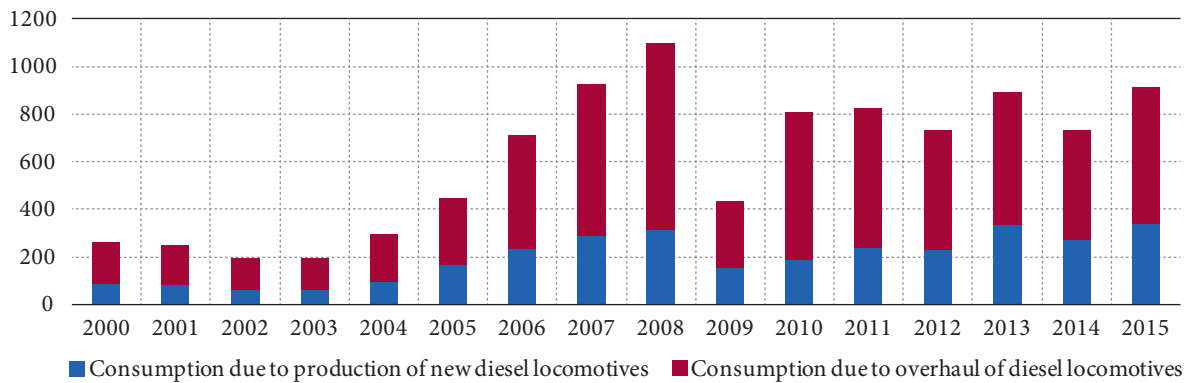

Fig. 3. Consumption of diesels for locomotives in 2000-2015.

## International cooperation

In order to develop diesel locomotive engines which comply with international standards, Transmashholding and Sinara Group have created joint enterprises with some of the world's leading diesel engine manufacturers. Partners in various projects now include Wartsila, Tognum, General Electric and AVL. In addition, Cummins and Caterpillar have supplied ready-made solutions for Russian locomotives.

However, most of these joint projects have not developed as they might have hoped. For example, the 2010 agreement between Wartsila and Transmashholding envisaged the creation of a joint enterprise at the Penzadieselmash plant which was planned to produce 250-300 engines a year, and was anticipated to begin production in 2012. For the Finnish company it would be its first experience of producing locomotive diesel engines. However, Transmashholding indicated in reporting for 2013 year that it has bought 50% stake of Wartsila in proposed joint production.

In 2013 Transmashholding announced a partnership with German engine manufacturer Tognum to launch production at the Kolomensky Zavod, with a corresponding memorandum of understanding signed at the economic forum in St Petersburg. It was expected that the enterprise would start work at the end of 2015 and produce up to 1000 diesel engines per year. The agreement also foresaw the creation of a joint engineering center for the development of diesel engines. However, the plans did not materialize, and the legal entity was liquidated in August 2015.

In February 2016, Transmashholding signed an agreement establishing a joint enterprise with General Electric (GE) in which both parties held 50%. The project involves the localization of production of GEVO diesel engines at the

Penzadieselmash plant. According to the agreement, the Russian and American companies plan to invest more than \$US 70m to begin production at the plant, including installation of the necessary equipment and staff training. The plan envisages initial production of up to 250 2900-4700kW units with the potential to further expand production capacity. The companies already have experience of successful cooperation, with the use of GEVO V12 engines in the upgrade of 2TE116U main line diesel freight locomotive currently the most popular new locomotive produced in the CIS. (Fig. 4.).

Another example of successful collaboration is the joint project between UDMZ and AVL, Austria, to develop a modern diesel engine for shunting locomotives. The project started in 2009, and the first contract encompassed the examination of a 8DM21 engine design to determine potential ways to upgrade the engine. The second contract covered the work to modernize the engine and was signed in October 2010. The upgraded diesel engine was designated as 8DM-21L and put into serial production for installation in TEM9 and TEM14 locomotives manufactured at Ludinovskiy diesel locomotive plant. The modified engine achieves targets to

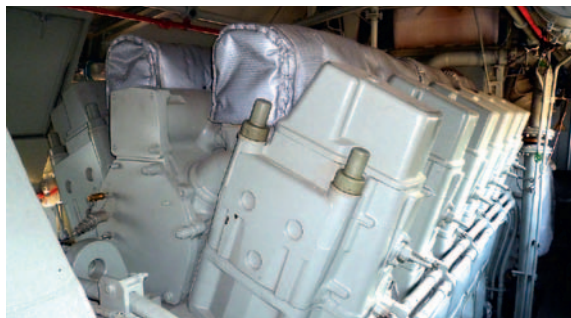

Fig. 4. GEVO engine installed in the 2TE116UD locomotive.

reduce fuel consumption and harmful emissions by a substantial margin with the results achieved without increasing the maximum combustion pressure. This enhanced the service-life-

stability of the engine, while the improved fuel consumption corresponds with that of equivalent units produced by overseas manufacturers.

## State support for the sector

While diesel engine development in Russia has benefitted from technology transfer agreements with international companies, the state is also active in stimulating development. The Ministry of Industry and Trade announced in 2012 a €235m federal initiative from which manufacturers can secure funds to assist with the development of a new generation of diesel engine production (Table 1).

**Table 1.** Contracts signed for R&D within the state program

Years	2011	2012	2013	2014	2015
Number of contracts	-	17	31	34	26
Cost of contracts [mln. Euro]	-	16.03	19.26	29.46	32.9

In February 2012 UDMZ won one of the subprogram competitions and secured financing to develop a family of high-speed V-shaped diesel engines and test rigs. The Energodizel project called for development of a new family of diesel engines with a power rating of 1000-3000 kW, with the test rig project named Dizelstroy. The state financed about 49% of the projects' costs.

By December 2012, UDMZ had completed the first phase of Energodizel and Dizelstroy. So far, Energodizel has produced nine draft designs for diesels and seven draft designs for diesel-generators, with assembly, manufacturing and testing of two prototypes carried out.

## Own solutions

New developments are carried out in-house by manufacturers of diesel engines. With a lack of Russian-made diesel engines with a cylinder capacity in the range of 300-500hp, it was decided to create the new D500 series at the Kolomensky Zavod (ChN26.5/31).

Development of a 12-cylinder engine, 12LDG500 with output of 4420kW (6000 hp) for heavy freight mainline locomotives able to haul trains of up to 12,000 tons in Siberia and the Far East was the first project. The prototype was presented at Expo 1520 in 2015 (Fig. 5). Along with the D500 family of diesel engines, with D200 and D300 series engines developed in parallel to expand the power range. The engineering solutions incorporated in the new

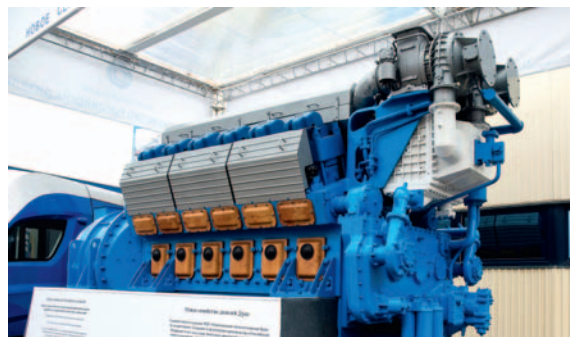

**Fig. 5.** 12LDG500 diesel engine at Expo 1520 in 2015.

engine are equivalent to the modern standards set by renowned manufacturers and provide enhanced technical and economic performance.

## Prospects

We are currently experiencing a transformation in the Russian locomotive diesel engine market. A shift is underway to using new generation diesel engines supplied by foreign companies and produced by Russian suppliers through Russia's policy of openness for foreign companies. The state is also actively contributing to the creation of joint enterprises, engineering centers and laboratories.

Major repairs or replacement of the locomotive power unit will be required for about 2500 locomotives operated in Russia in the next five years. Russia currently requires 850 diesel engines every year, and the market is worth more than €200m. There is particularly high demand for high-quality medium-speed engines and, especially, their components. Ⓢ

## Russian innovative technologies



**Igor Mikhalkin,**  
CEO of INFOTRANS

From 2008 the Russian company INFOTRANS is a permanent participant of the exhibition InnoTrans. On this exhibition it presents its latest products and progressive projects. For the last years the company has expanded its scope of activities and passed the bounds of the «Region 1520». It has its confident position on the markets of Europe, South-East Asia and Africa.

For more than 25 years INFOTRANS has its solid position in the sphere of development and production of the systems, units, IT-technologies for providing of the railway traffic safety. When designing the products INFOTRANS pays the attention especially to modularity and flexibility of the structure, complexity of the issues to be solved, automation of the procedures and reliability of operation.

The company has earned the respect and confidence by the foreign railway companies acting on the markets of the Western Europe due to its non-standard approach, sense of responsibility, orientation to the optimal solution. The first system developed by INFOTRANS for Western Europe was installed on the new generation diagnostic train of the Deutsche Bahn, named «RaiLab». The innovative system for control of the track- and rail geometry, named «MIBIS», provides control of the whole range of parameters, which are required by the European standards and Regional regulations. The main characteristic of this system is a high accuracy when measuring with low speed, practically by 0 km/h. The threshold control speed is 350 km/h. The system operated in the wide range of the weather conditions. The control of the complicated hardware and software complex is fully automated.

Another version of this system – MIBIS-AutoHS – is installed in the high-speed passenger train «Sapsan» (Siemens Velaro Rus). It was a Co-Project between JSC «Russian Railways», JSC RPC INFOTRANS and «Siemens AG». This system allows remaining all the seats. It's a full automated system, which can run without an operator. The measurements are carried out within the standard traffic of the passenger train. All the measured data are processed and evaluated. When identifying the dangerous situation all the necessary information is automatically transmitted through the radio channel to the predefined consumers in order to take a prompt management decision.

Nowadays the company INFOTRANS works on the project named “Gezogenes Diagnosefahrzeug gDFZ” (non-



Diagnostic train MISS DVT (DB)

self-propelled diagnostic train) for the Swiss Railways (SBB AG) including the wide range of the measuring systems for control of the state of the technical infrastructure objects. One of the purpose functions of the project gDFZ is control of the state of the longest tunnel in the world named Gotthard. In order to execute this challenging project the Company has created an international cooperation consisting of the leading companies from Germany, Swiss and Italy.

The activity of INFOTRANS doesn't only include developing of the diagnostic units. INFOTRANS works on developing of the technologies for application of the measured data too. An informational and analytical system for monitoring and diagnostics «EXPERT» was produced as a result of the long-term work. This system allows acquisition of data from all diagnostic units, their storage, synchronization and processing in order to carry out the offline analysis of the state of the infrastructure, analysis of its components and in order to plan the repair works. The main characteristics of the system are its open structure, scalability and orientation on Web-technologies.

INFOTRANS is always searching for new solutions and it's ready for effective cooperation.

**We invite you to visit our stand No.221, Hall 5.2. **

# Innovative messenger wire for an overhead contact line system

**Vasiliy Kuryanov,**

PhD, Associate Professor of Electro Power and Electrical Engineering at the branch of MPEI National Research University in Volzhskiy, Russia

**Makhud Sultanov,**

PhD, Associate Professor of Heat and Power Engineering and the director of the branch of MPEI National Research University in Volzhskiy, Russia

**Victor Fokin,**

Director, Energoservice LLS

## Introduction

An indicator of the efficiency of electrical energy use is the level of losses recorded during transportation and use. Increasing the efficiency of this process therefore is a major task for today's society and business, including the railway industry. The primary components and methods of transporting electricity in an

over-head contact line system for railways are shown in Figure 1.

The messenger or catenary is no less of an important element of the overhead catenary system than the contact wire, both from the point of view of reliability, and from the point of view of energy efficiency.

## Innovative messenger wire

In order to improve this system, Russian developers have come up with new components and methods designed to enhance the performance of the messenger wire. As well as boasting high mechanical durability, limiting changes in wire length during fluctuations in temperature, and

boosting resistance to corrosion, by utilizing copper, the electrical conductivity of the wire and its aerodynamic characteristics are improved. At the same time the wire is compatible with standard fittings and suitable for mass production. In addition, plastically deformed catenary CC brand wires are

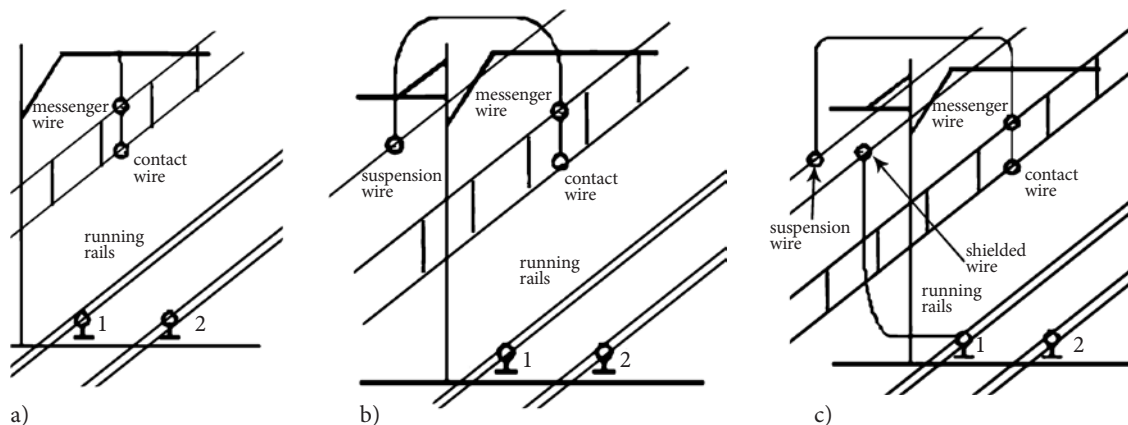

**Fig. 1.** Description of overhead contact line system of railways:

a) the catenary (messenger) wire, the contact wire, running rails;

b) the same but with the a reinforcing wire;

c) the catenary wire, the contact wire, the reinforcing wire – (reverse) wire, connected in parallel with the rails



suitable for supporting not only the bearing cable, but also to strengthen other wires used including the electric connectors of a contact suspension bracket and feeding line wires.

There are number of advantages of using a new copper wire besides its enhanced durability and capability to limits the use of the alloys in the system: it reduces the amplitude and intensity of jumping and the probability of break when a connected cable is damaged as a result of external influences. It also reduces the level of fatigue of metal in the cable; increases life cycle due to self-clearing of fluctuations; reduces snow accumulation and frost formation at the expense of a unique design; has high mechanical durability; reports on slight changes in length following fluctuations in temperature; steady against corrosion; good electric conductivity; excellent aerodynamic characteristics; standard diameters; and is suitable for mass production without compromising the cost of the final product.



Fig. 2. The foto of different compacted wires

To highlight these characteristics in a messenger wire, we will consider the example of the copper compacted wire CC-120 which is proven to be an effective product. This wire consists of 36 condensed copper wires of various diameters, and has an increased strength and lower resistance. Figure 2 shows a foto of different compacted wires. Comparative characteristics of some of the catenary wires used in Russia are presented in Table 1.

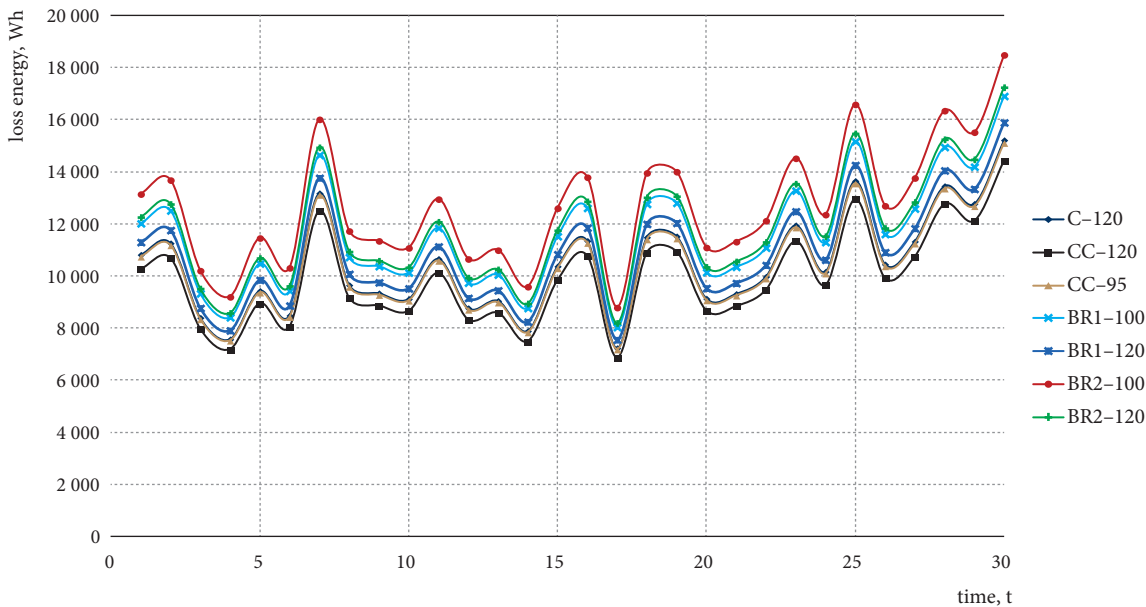

Fig. 3. Variations in the loss of electrical power in different messenger wires

Table 1. Comparative characteristics of some of the catenary wires used in Russia

Indicator	Catenary wires		
	C-120	C-150	CC-120
Nominal diameter, mm	14.0	15.8	14.0
Nominal cross section, mm <sup>2</sup>	120	150	120
Nominal area of the cross section of all the wires in the cable, mm <sup>2</sup>	117.0	148.0	140.06
Weight of 1 000 m cable, kg	1 045	1 321	1 251
Specific electric resistance at 20°C, Om/km	0.1580	0.1238	0.1383

## Analytical studies and evaluation of the effectiveness of the innovative messenger wire

**Table 2.** The average calculated loss of electrical energy and power

Brand of messenger wire	C-120	CC-120
Loss of electrical power, kWh	62,49	59,25
Loss of electrical energy, kWh/month	46 496,66	44 085,72
Loss of electrical energy, kWh/year	557 959,92	529 028,7

**Table 3.** The calculated loss of electrical energy and power

Indicator	Brand of messenger wire		
	C-120	CC-120	
Average for August 2014, the value of power losses	kW	62,518	59,27
Average for January 2015, the value of power losses	kW	62,47	59,23
Electrical energy losses in August 2014	kWh	46 513,46	44 101,652
	%	0,88	0,83
Electrical energy losses in January 2015	kWh	46 479,86	44 069,798
	%	0,88	0,84

The Volzhskiy branch of the Moscow Power Engineering Institute conducted an analysis of the technical losses of electrical energy in contact lines to determine the economical efficiency of CC messenger wires. The calculations show power losses and energy consumption for the summer and winter months for standard round and compacted wires. The results of calculations are presented in Tables 2 and 3.

Similar calculations were made for different brands of messenger wires. The results are shown the graph in Figure 3. In accordance with Russian Railways (RZD) requirements, modifications were made to the plastically deformed catenary wires to replace the steel core with zinc or copper-plated to increase their suitability for high-speed railways.

## Potential application of innovative messenger wires for overhead contact lines/catenary systems

At the 79th General Assembly of the International Electrotechnical Commission (IEC) held in Minsk in 2015, during a meeting of the TC-9 committee, "Electric equipment and systems for the railroads," the Russian delegation outlined the details of the existing international standards, "Railroad carrier cables of contact network GOST 32697-2014" including data on

the compacted wires. It also offered to initiate the development of the IEC new standard on the messenger wires for overhead contact line/catenary systems. A German patent for the construction and production technology plastically deformed steel wires and cables from different materials (Patent № DE-102014101833) was subsequently received in 2016.

## Conclusion

Replacing various messenger wires with the innovative plastically deformed carrying wire of MK series, which was developed following research into its settlement characteristics and use with a variety of catenary systems, will result in a decrease in electrical energy losses of 6-22% depending on extent and load of the catenary system. Introducing the new wire in catenary systems with high levels of railway traffic, and thus high electricity costs, is the most effective deployment method.

It would be expedient at reconstruction and construction of new railroads to apply this new innovative technology. The compacted wires offer strong electrical resistance due to the use

of a larger quantity of copper with an identical diameter which increases the wire's capacity and durability.

The AHG-14 working group created by the TC-9 committee continues to actively analyze the national standards of wires used in the IEC countries, and after considering the views of experts in the field, will submit its final conclusions on a new standard at the scheduled meeting of TC-9 committee in October 2016.



More information  
is available at  
[www.energoservice.com](http://www.energoservice.com). 

## Amsted Rail makes everything under the railcar body



**John Worries,**  
President, Amsted Rail

Amsted Rail is Amsted Industries' Chicago-based railway manufacturing division, the key products include but are not limited to bogies and bogie components, wheels, axles, journal box bearings, draft gears, couplers, and brakes for freight wagons and locomotives. Amsted Rail's products meet quality and safety requirements of AAR, UIC, and GOST regulations, and are customized as necessary based on technological features of 1000-1600 mm gauge railway systems and for rolling stock of 16-40 metric tons per axle loads; and may be further customized for customers' specific transportation needs.

For over a century, Amsted has held leading or prominent positions in designing and supplying bogie and component solutions to the North American railway market. Since the early 2000s, Amsted Rail has established significant presence, including joint ventures producing railcar components, in other regions of the world, such as Australia, Brazil, China, India, South Africa and Sweden. In the last decade Amsted Rail has established its footprint in the 1520 mm area: Russia, Ukraine, Belarus, and Kazakhstan.

Amsted's premier bogie for heavy-weight railway traffic – Motion Control bogie – has demonstrated superior performance in the harshest environmental and operational conditions in the Transpolar regions of Europe – Sweden and Norway – with non-failure runs of over 1 million kilometers under wagons of LKAB company loaded with iron ore.

In Russia Amsted was among the first to introduce innovative cassette-type bearings for journal boxes of both freight and passenger railcars. In 2008, Amsted Rail established a reliable strategic partnership and launched an effective joint venture with Russia's leading bearings manufacturer – EPK. The EPK-Brenco production facility in Saratov, Russia has localized both manufacturing and reconditioning of tapered railway bearings for railcars with 23.5 and 25 tons per axle load, with 800,000 kilometer run warranty. EPK-Brenco was the first full cycle facility certified to produce tapered roller bearings for freight and passenger applications in Russia and the rest of the 1520 mm area.



LKAB-operated F050 wagons on Amsted Rail's Motion Control bogies in Sweden

In the bogie manufacturing sector Amsted Rail has a strategic cooperation relationship with Russia's leader in innovative railcar building – United Wagon Company (UWC). UWC will soon launch serial production of Amsted Rail's Motion Control bogie specifically adapted by Amsted Rail designers for 1520 mm gauge. Amsted Rail also supplies some key components for the Barber bogies made by UWC in Tikhvin, Russia.

All participants and guests are welcome at Amsted Rail's exposition at Booth 303, Hall 20 at the InnoTrans-2016 exhibition where the company's qualified personnel will offer you further information about Amsted and its products. 



**Amsted Rail Headquarters**  
311 S. Wacker, Suite 5300  
Chicago, IL 60606  
Phone 312 922 4501  
<http://www.amstedrail.com/contact>

**Russia/CIS Office**  
Transolutions CIS  
Puteiskiy tupik 6, 10th floor,  
Moscow, Russia, 105064  
Phone 495 969 2669

## NIEFA-ENERGO aims for further development of Russian Railways



**Andrei Tiurikov,**  
CEO, NIEFA-ENERGO

For Russian Railways (RZD), the beginning of the 21st century was a period where solutions were sought for two major strategic tasks: modernization and reconstruction of its existing primary railway infrastructure and construction of new high-speed lines. Modern designers and manufacturers of innovative equipment soon emerged to meet this demand, one of which is NIEFA-ENERGO. Today the company from St. Petersburg is Russia's leading designer and manufacturer of modern traction equipment for main line railways and metros as well as general industrial facilities. We invite delegates of InnoTrans 2016 to visit our exhibit in Hall 15.1, stand 208.

### Targeting Russia's 43 000 km network

NIEFA-ENERGO was founded in 2000 from one of St. Petersburg's most renowned scientific institutions, FSUE NIEFA, which is named after D. V. Efremov, and is part of state-owned ROSATOM, which has a track record of working closely with RZD.

The company benefits from modern buildings and production areas which were built over a very short period, and include innovative scientific and technological design and test facilities.

By 2016, NIEFA-ENERGO had developed and supplied equipment for more than 200 traction substations and distribution substations, and 160 sectioning points and railway power supply points. Russia's 43 000 km of electrified railways, from Kaliningrad to Vladivostok, is effectively a testing ground for introduction and implementation of the company's developments. The successful implementation of a large number of projects has enabled NIEFA-ENERGO to conclude a cooperative agreement with RZD that will last up to 2020.

### Turnkey equipment offers a competitive advantage



Traction substation 110/27.5 /10/3.3kV at Engels locomotive-building plant

The company strives to develop and produce complex and high-quality electrical equipment for railways, including for special projects and turnkey installations. NIEFA-ENERGO's specialists carry out the whole scope of work, from research, design, and engineering to installation, start-up and adjustment, warranty and maintenance service work.

One of the company's main advantages which is enabling it to beat its competitors in equipment tenders is the production of functional units for traction substations. The benefits of this system is that it enables the delivery and installation of a complete-block type, while the high availability of equipment reduces implementation times. In addition, the use of the blocks in various combinations depending on the project



requirements, ease of installation and assembly, and the complete-block method ensures the reliability of the units and reduces production costs.

Some of NIIIEFA-ENERGO's main products are:

- DC traction substations with transformers power up to 12.5 MVA;
- AC traction substations with equipment for 25 kV and 2x25 kV;
- microprocessor bay controllers included in an automated control system for traction substations;
- high-speed DC circuit breakers for voltage of 3 kV, 825 V, 600 V (VAB type);
- semiconductor rectifiers;
- AC and DC switchgear panels;
- devices increase traction power supply, including: DC boosters, voltage converting points, sectioning points, autotransformer points for 2x25 kV system;
- reactive power filter compensating devices which help to significantly reduce energy consumption.

## A major player in Russian megaprojects

Its wide range of high-quality products has firmly established NIIIEFA-ENERGO as the market leader in its sector. In addition, its ability to offer a comprehensive range of after-sales services throughout delivery, commissioning and service has helped the company become an official supplier for Russia's largest rail infrastructure projects.

One of the first projects was the reconstruction of the St Petersburg – Moscow line for high-speed traffic in the early 2000s. During the project, NIIIEFA-ENERGO was tasked to boost power along the whole line. By 2005 additional traction substations were designed and built, the existing facilities were reconstructed and modernized, while new linear and traction equipment was installed. The company participated in similar activities for the reconstruction of the St. Petersburg – Helsinki for high-speed operation. This project was implemented in 2012.

In course of preparation for the 2014 Winter Olympics in Sochi, the company supplied electrical equipment for the reconstruction of the Tuapse – Adler section of the North Caucasian Railway. This included complete replacement of traction substation equipment. In addition, two new AC substations were constructed for the project.

Today, the company continues to participate in Russia's largest and most important infrastructure projects, including the reconstruction of the Eastern Railway, from the Urals to the Far East. As part of the project, NIIIEFA-ENERGO is upgrading four separate railways' electrification systems: the Krasnoyarsk Railway, the East-Siberian Railway, the Trans-Baikal Railway, and the Far East Railway.

The project will enable heavy freight trains with loads of up to 10 000-12 000 tons to use the infrastructure. To increase the Trans-Siberian line's freight throughput capacity electric traction equipment must also be replaced while additional capacity enhancing systems must be



DC switchgear 3.3 kV and AC switchgear 10 kV at traction substation on the St. Petersburg - Buslovskaya section of the Oktyabrskaya Railway

installed. Within the few next years, NIIIEFA-ENERGO will begin work on achieving this.

Another promising project is the construction of the new 770 km Moscow – Kazan high-speed line. NIIIEFA-ENERGO is involved in the technical development of electrification for the project.

NIIIEFA-ENERGO is also a major supplier of electric equipment for a number of other industries, and has extensive experience of supplying large general-industrial appliances. For over 10 years, the company has developed and manufactured modern electric traction equipment for underground and the company will play a major part in underground network upgrades which will take place in preparation for the FIFA football World Cup, which Russia is hosting in 2018.

NIIIEFA-ENERGO's products are now widely recognized in Russia and increasingly by international customers, including in China, India and Iran. This was reflected in its successful participation at InnoTrans 2014. The company hopes for similar success at InnoTrans 2016, where it will exhibit its products to prospective international customers. 

# Developing and Mastering Wheels for High-Speed EMU “Lastochka”

**Andrey Kamyshny,**

Manager for new products and research works, R&D Center, Vyksa Steel Works JSC

**Dmitry Kerentsev,**

Main specialist in design of railway wheels, R&D Center, Vyksa Steel Works JSC

**Roman Timakov,**

Lead Specialist, R&D Center, Vyksa Steel Works JSC

Growing fleet utilization and rail service operating speeds are placing increasing strain on Russian Railway's (RZD) rolling stock. To meet these demands, RZD decided to modernise and renew its commuter fleet by replacing ageing trains with reliable EMUs which satisfy modern transport requirements.

In December 2009, Russian Railways (RZD) awarded Siemens a contract to develop EMUs based on the German manufacturer's Desiro ML platform, which were subsequently branded Lastochka [1]. Under the agreement, domestic production of solid-rolled wheels for Lastochka was implemented at Vyksa Steel Works JSC (VSW).

Today, solid-rolled wheels with a diameter of 957mm and featuring a flat-conical wheel disk form manufactured at the site as per official Russian standard, GOST 10791-2011 [2]. The standard covers solid-rolled wheels for both freight wagons and passenger coaches and the wheels have now been widely adopted on Russian rolling stock.

The technical features of wheels developed specifically for Lastochka follow more stringent requirements than typical applications according to:

- steel quality,

- mechanical properties,
- level of residual stresses in the web surface layer, and
- design of the solid-rolled wheel for powered and non-powered rolling stock.

The technical requirements for solid-rolled wheels have been developed by specialists at Railway Research Institute JSC (JSC VNIIZhT) and VSW and are reflected in the specification TU 0943-265-01124323-2011 “Solid-Rolled Wheels for Lastochka EMUs.” The advantage of developing these technical requirements is their compliance with the wheel quality indicators used in Russian and European basic standards: GOST 10791-2011 and EN 13262:2004+A2:2011.

A trial of the solid-rolled wheels in operation was conducted in the first quarter of 2015. The wheels were manufactured from domestically-produced steel and the following is an in-depth look at the wheel's basic characteristics and the technical solutions used.

## Quality Indicators of Solid-Rolled Wheel Steel

Steel grade 2 as per GOST 10791-2011 is the basic material that provides the desired set of mechanical properties for the solid-rolled wheel. The selected range of steel chemistry also complies with steel grade ER9 as per EN 13262:2004+A2:2011.

To increase the reliability of solid-rolled wheels, a technical solution proven to help to reduce steel contamination with endogenous non-metallic materials was utilized.

A secondary refinement technology at LRF-VD, which ensures oxygen content is no more than 0.0025% (25ppm), nitrogen content is no more than 0.0070% (70ppm), and hydrogen content is no more than 0.0002% (2ppm) was used with liquid steel. Reducing steel contamination with exogenous nonmetallic inclusions was obtained through use of heat-resistant ceramics.

This steel manufacturing technology is designed to avoid defects that would deem the

product a reject. For a UT wheel rim in both the axial and radial direction a rejectable defect is defined as having a diameter of no more than 2mm, and no more than 3mm on the UT wheel web and hub in the axial direction.

The steel chemistry of the solid-rolled wheels used on Lastochka is shown in Table 1.

Contamination of wheel steel with non-metallic inclusions was checked as per GOST 1778 (method Sh1) by average point and separately for each type inclusions. The actual values of contamination of trial lot wheel steel with nonmetallic inclusions are shown in Table 2.

**Table 1.** Steel chemistry of solid-rolled wheels for Lastochka

Mass fraction, %									
C	Mn	Si	V	S	P	Cr	Ni	Cu	Mo
			not more than						
0.53-0.60	0.50-0.80	0.22-0.40	0.06	0.015	0.020	0.30	0.30	0.30	0.08

**Table 2.** Contamination of wheel rims steel with non-metallic inclusions

Type of inclusions	Average point as per requirements of specs TU 0943-265-01124323-2011, not more than	Actual point of contamination for trial heat 07572
Stringer oxides	1.0	
Point oxides	2.5	0.5
Brittle silicates	2.0	
Plastic silicates	1.5	
Nondeformable silicates	2.5	
Sulphides	2.0	1.0

## Mechanical Properties of Solid-Rolled Wheels

Heat treatment of solid-rolled wheels consists of interrupted quenching of the rim followed by tempering. The temperature of the wheel for the quenching process exceeds the austenitizing temperature by 30-50°C. The wheel rims are cooled using a water-air mix delivered using sprayers which ensure the process takes place at the specified speed. To ease possible residual stresses, solid-rolled wheels were subject to

tempering at temperatures of at least 450°C.

Due to the wheel thermo-strengthening process, wheel rims acquire a highly dispersed ferritic-pearlitic structure, while the web and hub structure complies with a normalized state.

The wheel's mechanical properties obtained when testing as per GOST 10791-2011 are shown in table 3, and in table 4 when testing as per EN 13262:2004+A2:2011.

## Level of Residual Stresses in Surface Layer of Solid-Rolled Wheel Webs

When in service, solid-rolled wheels are subject to varying loads which influence their stressed condition. For example residual tensile stresses in the surface layer of solid-rolled wheels reduce structural strength, contributing to the formation of primary cracks at lower loads. An important criterion therefore to ensure the reliability of solid-rolled wheels is to guarantee that a specified

level of residual stress is present in the surface layer of the wheel web. Only when this condition is guaranteed are solid-rolled thermo-strengthened wheels subject to final machining.

The specific requirements for machining solid-rolled wheels for Lastochka, together with accuracy of manufacturing and roughness of the work surface, stipulates forming residual

**Table 3.** Results of mechanical properties of solid-rolled wheels tested as per GOST 10791-2011

Heat No.	Rim							Web	
	Ultimate strength, N/mm <sup>2</sup>	Percentage elongation, %	Percentage reduction, %	Impact toughness KCU average, J/cm <sup>2</sup>	Hardness, HB		Crack resistance, MPa * m <sup>1/2</sup>	Impact toughness KCU average, J/cm <sup>2</sup>	
					At point A	At point B at 30 mm depth		+ 20 °C	- 60 °C
Normatives as per GOST 10791-2011									
910-1110	8	14	20	by 15 HB less than p.B		≥ 255	50	20	15
07572	1,020	11	34	38	42	294	97	53	93

**Table 4.** Results of mechanical properties of solid-rolled wheels tested as per EN 13262:2004+A2:2011

Heat No.	Rim								Web		
	Ultimate strength, N/mm <sup>2</sup>	Yield strength, N/mm <sup>2</sup>	Percentage elongation, %	Impact energy KV J - 20 °C		Impact energy KV J + 20 °C		Hardness, HB		BUltimate strength, N/mm <sup>2</sup>	Percentage elongation, %
				Average	Minimum	Average	Minimum	At point A	At point B at 30 mm depth		
Normatives as per EN 13262:2004+A2:2011											
900-1050	≥ 580	≥ 12	8	5	13	9	by 10 HB less than p.B		≥255	≥ 130 reduction towards ultimate strength of the rim	≥14
07572	1010	770	12	15	13	23	23	252	300 287 287	208	17

stresses in surface layer of the wheel web, with these stresses no more than +200 MPa.

Machining of the solid-rolled wheel is the final technological operation of the manufacturer and it is a critical process as residual stress levels in the surface layer depend on machining conditions, the type of cutting tool applied and any allowances for final machining.

In order to define the optimal cutting parameters, a number of industrial trials have evaluated the influence of machining parameters on the final outcome. These include variations in the tool feed and cutting speeds on the residual stress level in the surface layer of wheel webs where the stresses are measured using an X-ray.



The trials found that increases in tool feed speeds in the range of 0.1 to 0.4 mm/rev result in a decrease in compressive stresses and an increase in tensile stresses.

The increase in cutting speed in the range of 100 to 160m/min results in an increase in tensile stress levels from 100MPa to 400MPa.

Further increases in cutting speed from 160 to 200m/min decreases tensile stresses by up to 200MPa. However, increasing the cutting speed to 200m/min leads to a significant increase of heat at the work surface in the cutting area which adversely affects the structural condition of the metal work surface.

## Solid-Rolled Wheel Design for Powered and Non-Powered Rolling Stock

A significant design feature of Lastochka is the use of disk-type brakes on the powered bogie, which are attached directly to the wheel from both the inside and outside. To accommodate this feature, the wheel design encompasses special fields and holes in the web which places greater demand on accuracy during the fabrication process. In turn, a non-powered bogie permits the use of disk-type brakes mounted onto the wheelset axle, alleviating the need for holes on the web of these wheels.

In view of the fact that the Desiro EMU platform on which Lastochka is based follows the requirements of European railways, the wheels have an outside tread diameter of 920mm. This compares with mass-produced wheels for the Russian market which have a nominal diameter of 957mm.

Despite significant differences in design, the wheels confirmed their compliance with strength requirements outlined in European and Russian standards, with a view to using them with a maximum static load per wheelset axle of 19 tonnes (Fig. 1).

The Federal Railway Transport Certification Register (FBU) have confirmed the product's compliance with the established requirements for production. On January 22, 2013, VSW received Conformance Certificate of Federal Railway Transport Certification Services to develop a batch of 2,500 wheels for powered and 2,500 wheels for non-powered bogies for the Lastochka EMU. In October 2015, VSW received a Certificate of Conformance of Customs Union, confirming the wheel's compliance with the Technical Regulation of Customs Union Standard 001/2011 "On Safety of Railway Rolling Stock." In November 2015, Siemens completed the procedure to approve VSW as a supplier of wheels for the Lastochka.

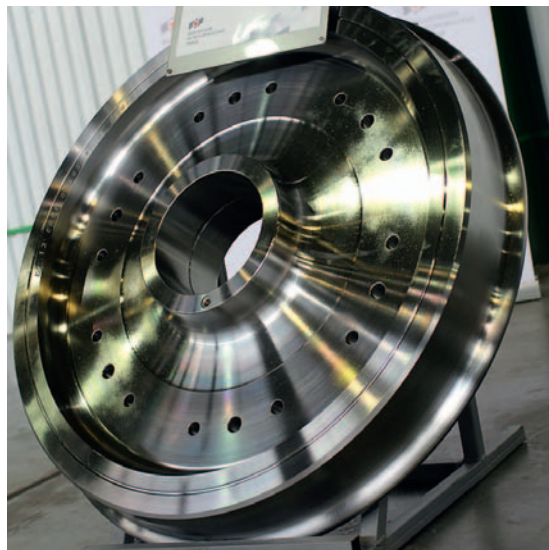



Fig. 1. Solid-rolled powered wheel for the Lastochka EMU

The work to develop the required manufacturing technology, and certification and qualification, made the supply of wheels for the Lastochka EMU to Russian and European customers possible. In addition, the wheels compliance with the quality indicator requirements for wheels for both Russian and European customers solves the localisation requirement for manufacturing solid-rolled wheels for Lastochka EMUs in the Russian Federation.

### List of references:

1. W.Zigler. Desiro RUS – Promising Commuter Train / W.Zigler, R. Mangler // Railways of the World. - 2012). - №4. - P. 44–51.
2. GOST 10791-2011. Wrought Wheels. Technical Specifications. - Intr. 2012-01-01. - M.: Standardinform, 2011. - 27 p.
3. EN 13262:2004+A2:2011 Railway Applications – Wheelsets and Bogies – Wheels – Product Requirements: – 2011. 47 p. 

# Innovative electric traction system offers major benefits for railways

**Alexandr Kireev,**

PhD in Technical Science, CEO of Research and Development Center “Privod-N” CJSC

**Nikolay Kozhemyaka,**

PhD in Technical Science, Technical Director of Research and Development Center “Privod-N” CJSC

**Sergey Sudakov,**

Chairman of the Management Board, “Advanced Electrotransmission” Group Corporation

Reducing the life cycle costs of railway transport, which in turn will reduce transport’s share of the cost of goods and services, should be a key goal for all research and development in this field. One area where this is applicable is work to enhance traction systems. Utilizing electric traction based on switched reluctance motors to replace conventional electric collector motors can significantly improve the reliability of vehicles as well as their efficiency.

In recent years, along with widely-used asynchronous and synchronous motors equipped with permanent magnets, there has been an intensive development of electric traction system based on switched reluctance applications. This has a number of advantages which distinguishes the technology from traditional analog systems. Firstly, it offers higher reliability due to simplicity of motor design: no windings at the rotor and the existence of simple lumped coils without intersections in the face parts. Secondly, these design features help to realize a higher torque value at the shaft, an extended rotation frequency, increases in the value of drive’s efficiency factor, and reductions in production and maintenance cost. Indeed, each of these factors can contribute to a substantial reduction in the vehicles life cycle cost.

In addition, the magnetic independence of phase circuits provides the means for autonomous energy supply to the motors phase windings by utilizing unipolar current from the traction converter, which is resistant to short circuits. This helps to reduce losses in the steel and at the same time ensure the vitality of the drive if a fault occurs.

Studies of reluctance electric traction systems have shown that this area is an area of major potential improvement in traction as well as more general operational and economic performance of railway transport. For instance, a motor for an electric train has

been shown to have a capacity of 350kW an hour [1]. The motor is designed as a three-phase electrical system with salient poles formed by the tooth structure of stator and rotor. It is built in the same overall dimension as the asynchronous motor of the same power, and uses a number of its components and assembly units. For example, phase windings are located at the stator teeth and the coils of each phase are placed circumferentially at the stator in mutually perpendicular directions and connected in pairs and in series. The output of the starts and ends of each pair are entered into the external circuit by flexible cables. The motor design is developed with application of the concept of frameless performance which allows better use of the specified dimension for active materials and thereby provides an increase in power density. Tests have proven that the reluctance motor can realize a higher efficiency than an asynchronous motor of the same power, and a wider range of rotational frequency and loads.

The Research and Development Center “Privod-N” in Novocherkassk, Russia, has designed traction equipment for shunting diesel locomotives with electric power transmission [2]. Specifically this includes traction generator TRIG-680, traction motor TRID-125, traction converters BPS-400 and BPS-680, microprocessor control and diagnostic system BUT. The general layout of traction equipment of diesel locomotive is presented in Figure 1.

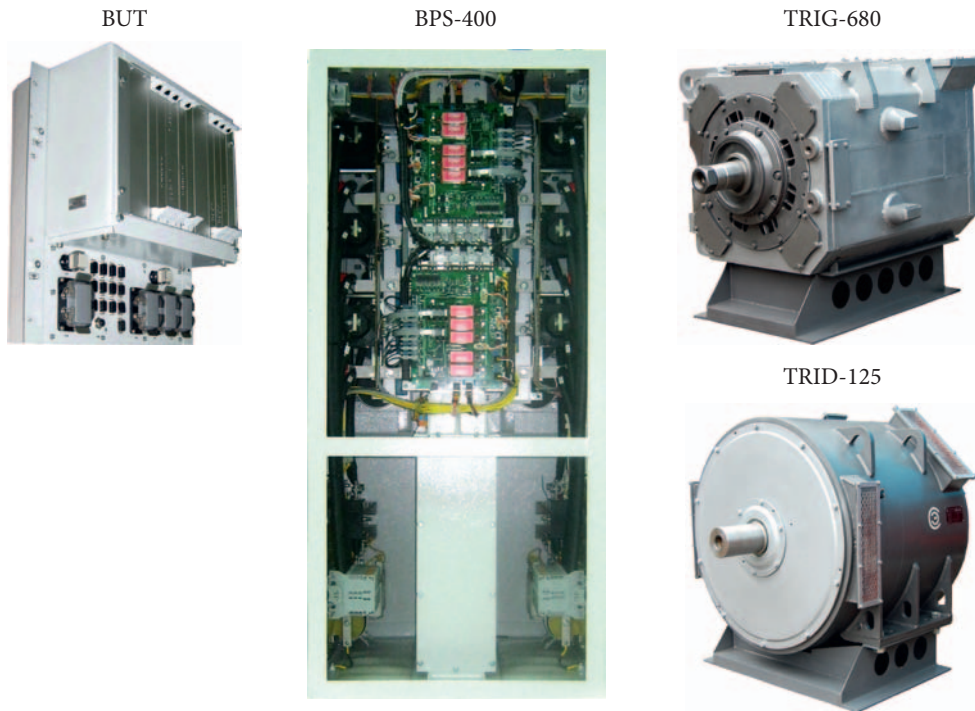

Fig. 1. General layout of electric equipment

It should be noted that a switched reluctance electric system offers electromagnetic reduction due to the ability to set the shaft speed by selecting the precise number of stator and rotor teeth. This capability is particularly useful in the design of low-speed, high-torque motors. For example, traction motor Trid-125 has been designed with the use of this characteristic. It is able to create the starting torque ( $M$ ) of 10,300Nm and provide long-term mode of power constancy ( $p$ ) of 200kW in the range of rotation frequencies ( $n$ ) of between 270 and 2,400 revolutions per minute. The motor's mechanical properties are shown in Figure 2.

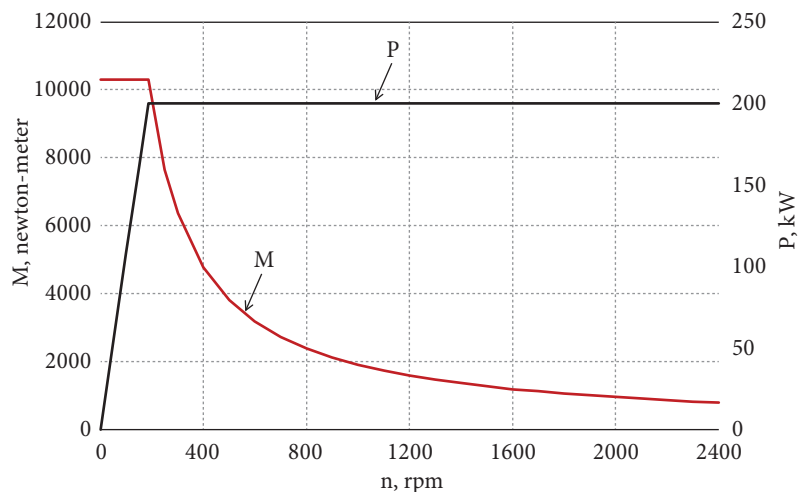

Fig. 2. Mechanical characteristic of TRID-125

A special feature of generator Trig-680 is the ability to maintain a constant output voltage value when the shaft speed operates in the range of between 600 and 1,800 revolutions per minute. The rated output of Trig-680 is between 1,500 and 1,800 revolutions per minute. In addition, the generator together with converter BPS-680 supports operation in motor mode. This characteristic can be used for diesel starting as well as for electric braking and powering the diesel cooling system. The load characteristic of Trig-680 is shown in Figure 3.

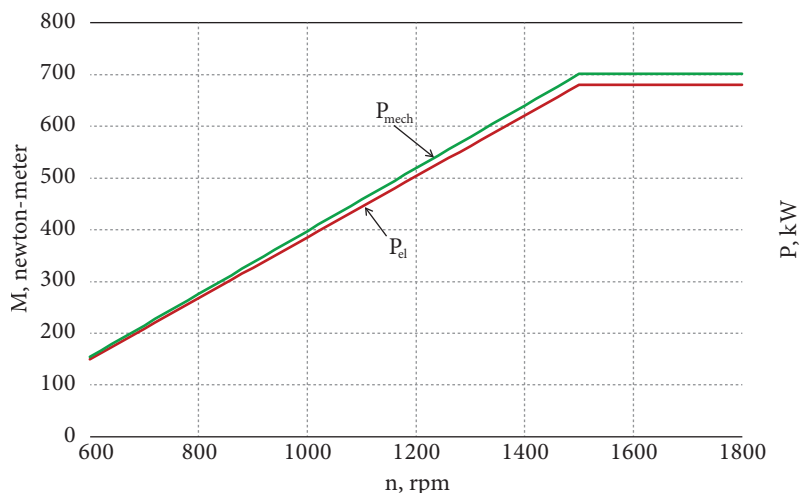

Fig. 3. Load characteristic of TRIG-680

Improvements in the electric traction equipment design is timely as it coincides with the upcoming renewal and replacement of much of Russian Railways (RZD) shunting locomotive fleet. RZD has challenged the

**Table 1.** Comparison characteristics of shunting diesel locomotives

Parameter	CHME3	TEM9	TEM18DM	TEM33	TEM35	TEM-I 6 axles	TEM-I 4 axles	TEM-I hybrid
Axle characteristic	3 <sub>0</sub> -3 <sub>0</sub>	2 <sub>0</sub> -2 <sub>0</sub>	3 <sub>0</sub> -3 <sub>0</sub>	3 <sub>0</sub> -3 <sub>0</sub>	3 <sub>0</sub> -3 <sub>0</sub>	3 <sub>0</sub> -3 <sub>0</sub>	2 <sub>0</sub> -2 <sub>0</sub>	2 <sub>0</sub> -2 <sub>0</sub>
Diesel power, kW	1,000	882	882	2x571	571	2 x 522	680	250
Energy storage capacity, kW	-	-	-	-	500	-	-	400
Service weight, t	123	90	126	123	123	138	90	90
Traction effort when starting, kN	302	291	319	362	362	495	340	340
Traction effort under continuous mode, kN	225.63	217	206	226	226	350	235	235
Speed under continuous mode, km/h	11.4	10.5	10.5	-	-	8.4	7.5	7.5
Transmission type	DC-DC	AC-DC	DC-DC	AC-AC	AC-AC	AC-AC	AC-AC	AC-AC
Diesel capacity factor at traction	0.71	0.72	0.68	-	-	0.78	0.72	-

supply industry to develop and deliver new rolling stock equipped with innovative electric traction systems as well as to update existing locomotives to extend their service life and improve technical and economic characteristics.

Currently 87% of RZD's shunting locomotive fleet is made up of variants of the CHME3 diesel locomotive and TEM2 locomotives, with around 90% of these units deemed to be reaching the end of their service life. However, with limited opportunity to purchase new diesel shunting locomotives, realizing complex measures to improve the units' technical condition and extend its life are just as critical as developing updated locomotive models based on CHME3 and TEM2 series.

A preliminary assessment has shown that TEM2 diesel locomotives with two advanced diesel engines as well as power transmission using traction reluctance motor and reluctance generators will offer the following improvements in traction performance: increases in traction effort when starting from 390 to 450kN, and from 200 to 350kN in continuous operation mode; and a 25% improvement in fuel economy due to the following factors: a 9% decrease in fuel consumption while idle, 7% higher average power transmission operating efficiency, 7% diesel operation in the area of low fuel consumption, and 2% savings by implementing controlled drive of auxiliary systems.

The electric equipment is designed to integrate into the underframe of any diesel shunting locomotive with power transmission, operated in both Russian and international networks, and it applies to diesel locomotives manufactured during Soviet times, such as the TEM1, TEM2, CHME3, as well as contemporary

diesel locomotives such as the TEM 18, TEM 103, TEM 9, TEM 9H, TEM 31, TEM 7, TEM 35, and TEM 33. In addition, there are several different diesel locomotive power concepts and units available: classic single-diesel, multi-diesel and hybrid.

Table 1 presents the comparison characteristics of existing shunting diesel locomotives and the advanced shunting diesel locomotive TEM-I based on the reluctance electric traction system.

Electric traction based on switched reluctance applications are suitable not only for diesel shunting locomotives but for main line diesel locomotives, multiple units, track-repairing machines and industrial locomotives.

In addition, by utilizing the benefits offered by a simple, reliable and energy efficient traction system, manufacturers of electric rolling stock have the opportunity to enhance their competitive position in the railway marketplace.

#### List of references:

1. Kireev A.V. Traction drive with reluctance motors /A.V. Kireev, G.N. Kononov, A.V. Lebedev, A.A. Kulishov// VELNII newsletter: scientific publication. / JSC «VELNII». – 2007. – № 2 (54). – p. 14–23.
2. Kireev A.V. Energy saving power electric transmission of shunting diesel locomotive / Kireev A.V., Kozhemyaka N.M., Kononov G.N. // IV International Partner Conference EuroTrain « Advanced rolling stock: priorities, innovation, prospects », 10–15 June 2013, Yalta. – p. 86. 



## Expo 1520 is waiting for foreign guests

Over the past 10 years, the bi-annual Expo 1520 Salon that takes place in Shcherbinka, near Moscow, has established itself as the leading railway forum in Eastern Europe and the CIS. The industry's key figures gather at the event, including representatives of Russian Railways (RZD), other transport companies operating in the 1520mm-gauge region, and manufacturers of Russian and international rolling stock and components. The fifth Expo 1520 Salon held on September 2-5 2015 confirmed the growing importance of the event and its organizers are now planning on further expansion to include a greater emphasis on urban rail transport.

### 5th EXPO 1520 Salon in figures

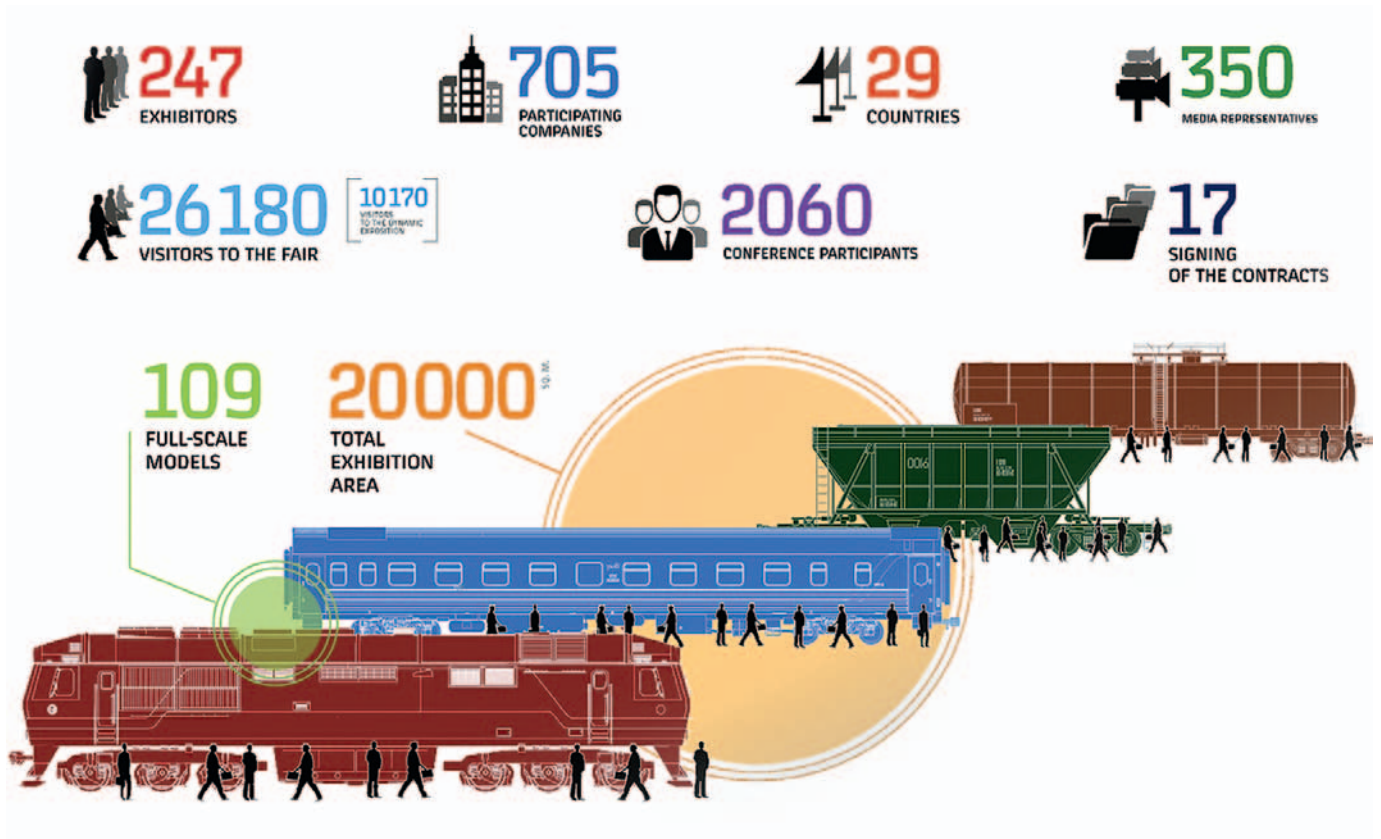

For companies developing new rolling stock, track equipment and technological innovations designed for operation with 1520mm-gauge infrastructure, exhibiting at Expo 1520 is an important factor for future success. Virtually all the major procurement and implementation contracts for new rolling stock in the 1520 region were signed during the exhibition. In 2015 these included a contract between the United Wagon Company and the Wabtec to export rail castings into the United States, and an agreement between Transmashholding, Alstom, NIIAS and Skolkovo Fund to establish a railway automation center in Russia.

The Salon is split into three key areas: a conference dedicated to topical issues in railway engineering, an exhibition of manufacturers of railway equipment, and a unique parade of Russian railway equipment. Indeed participants can view the past, present and future of RZD at the VNIIZhT Experimental Ring. This includes legendary steam locomotives, diesel and electric locomotives that served the country for decades, as well as modern equipment developed by Russian companies including locomotives and vehicles developed and built in cooperation with western partners.



Russian Railways president Oleg Belozеров opens the 5th Expo 1520 Salon



A plenary session at the 5th Expo 1520 Salon

The conference is a now firmly established as a leading event for railway experts, representatives of the supply sector and state bodies with 2,060 delegates taking part in 2015. For manufacturers, participation in the conference is an opportunity to learn about the new needs of their customers and to outline future agreements. The debates arising during the plenary sessions also allow market participants, regulators and scientists to form a common vision of transport engineering in Russia.

With recent significant depreciations in the value of the ruble, as well as the development of a systemic foreign-economic approach by Russian authorities, the prospects of exporting Russian components into international production chains for rolling

stock has become particularly pertinent. Major international manufacturers including Alstom and Siemens say that possessing a component manufacturing base in Russia and/or partnerships with Russian manufacturers enables them to become more competitive in the international marketplace.

The next Expo 1520 will be held in September 2017 and we are confident that the event will again boast an inclusive atmosphere and allow a productive exchange of views and experience between people that devote themselves to the development of the railway. And in line with the tradition of the event, the doors of the Salon will be open to foreign guests and manufacturers because after all further development of rail transport in the 1520 region is impossible without international cooperation. 🌐



CRRC's stand at 5th Expo 1520 Salon



L series steam locomotive on display during the dynamic exposition

## Union of Industries of Railway Equipment (NP UIRE) in the international arena: results and prospects



**Nikolay Lysenko,**  
Executive Director, Vice President, NP UIRE

Since it was founded in June 2007, the Union of Industries of Railway Equipment (UIRE) has worked to establish strong communication and relations among international railway equipment producers so they can share their experience and technologies in order to enhance the production of rolling stock and components.

Today we can say with confidence that the UIRE brand, and its work, is becoming more and more recognizable around the world. But what is the evidence of this?

**Firstly**, companies from Germany, Ukraine, Belarus, Kazakhstan, Uzbekistan, Slovakia, as well as divisions of two of the largest global railway equipment manufacturers, Siemens and Alstom, which are working in the Russian Federation, have entered UIRE over the last nine years.

**Secondly**, since 2008, UIRE has become an active participant in the largest international railway exhibitions and conferences. This includes the Strategic Partnership 1520 in Sochi; Expo 1520 in Scherbinka; InnoTrans in Berlin; and the international industrial exhibition in Brno. Within the framework of these events, UIRE hosts conferences and round-table discussions relating to the development of railway engineering in Russia, to which foreign partners are invited.

**Thirdly**, UIRE was able to significantly expand its international contacts in 2016, and now agreements of cooperation and collaboration exist between UIRE and:

- European Railway Industry Association (UNIFE),
- Association of German Transport Companies (VDB),
- Swiss Railway Industry Association (Swissrail),
- French Association of Railway Industry (FIF),
- Association of Austria's Railway Industry, and
- Czech Railway Industry Association (ACRI).

Plans for prospective events are under development with each party in order to implement the necessary agreements.

In addition, in 2016 talks were held with representatives of the railway industry unions of Great Britain, the USA, and Canada, with each party agreeing to sign documents to expand their respective agreements for mutually beneficial cooperation. This includes a meeting in March with representatives of American railway industry companies, where the necessary steps for cooperation in 2016 were established.

Interaction has also continued in 2016 between representatives of UIRE and the Working Group 8 on Technical regulation during an industrialists round-table between Russia and the European Union. This considered possible forms of cooperation with developers of regulatory documents, with harmonizing specific sections of Russian regulations with EU norms important for further cooperation with European manufacturers.

**Fourthly**, UIRE actively works with its member companies to successfully introduce the requirements of the International Railway Industry Standard (IRIS). This has enabled more than 100 railway industry companies in Russia and the CIS to align their business management systems with international best practice.

Significant assistance for domestic companies is provided by Russia's Machine Builder Union, the committee of which reviews the problems arising from implementation of IRIS standard requirements. Experts from UIRE and Russian Railways JSC also participate permanent in the meetings of the IRIS Group's advisory board.

This included the meeting held on July 6-8 2016 in St. Petersburg where discussions



focused on the implementation of and the prospects for implementation of IRIS standards up to 2020.

**Fifthly**, UIRE conducts guest seminars at international partner companies to explore the developments of foreign companies in the field of railway transport and to improve the quality of products.

For example, on April 25-29 2016 a guest practical seminar organized by UIRE together with the Inspectorate Center “Acceptance of wagons and component parts” and SwissRail was held with Swiss companies to study their experiences of manufacturing rolling stock, components, signaling and control systems.

In total 15 managers and specialists from Russian Railways, Novochoerkassk Electric Locomotive Plant (NEVZ), Kolomensky Zavod (KZ), OMK, Factoria LS, Moscow State University of Railway Engineering (MIIT), Experimental Design Bureau of Automatics, Bryansk factory of absorbing gears, and Bee Pitron Electric attended the seminar. Participants also visited industry locations in Zurich, Winterthur, Altenrhein, Beringen, and Baden.

Hosting these international seminars under the auspices of the UIRE together with international partners helps members to establish new business contacts with representatives of various companies, as well as explore the latest developments in the railway sector.

In September 2015, the fifth edition of the International Railway Salon Expo 1520 took place in Scherbinka, near Moscow, which was attended by 705 companies, including 218 exhibitors from 29 countries, four more than attended the 2013 edition. The Forum’s conference was attended by 2,060 delegates, and the exhibition by more than 26,000 people. In addition, 109 rolling stock units, including 72 static and 37 dynamic displays, were on show at the VNIIZhT test track, which is adjacent to the exhibition.

UIRE was also a major contributor to the event and conducted the following activities:

**1. A general Meeting of the members of the Partnership** which was attended by 126 delegates from 109 member companies and more than 40 representatives of cooperating organizations. During the meeting 11 companies were nominated in UIRE’s competition for the best innovative design.

**2. A scientific and historical conference** devoted to the 170th anniversary of the

domestic transport manufacturing. In total, the conference was attended by over 250 delegates from 105 organizations and enterprises, as well as heads of Rosstandart, Ministry of Industry and Trade of the Russian Federation, Russian Union of Industrialists and Entrepreneurs (RUIE), and transport industry veterans.

The conference was supported by Committee on Economic Policy of the Federation Council, four Russian regions - Chuvash Republic, Vladimir, Sverdlovsk, and Penza Regions - and five international organizations, UNIFE, VDB, FIF, ACRI and Swissrail.

**3. During the event, the following agreements were signed:**

- A cooperative agreement between the UIRE and TÜV Rheinland’s Railway Competence Centre to develop joint activities in certification of railway equipment covering both conventional and high-speed applications.
- A road map of cooperation between UIRE and SwissRail up to 2020. The document was signed in presence of the Swiss Ambassador to the Russian Federation, Pierre Helga, and signed by Valentin Gapanovich, president of UIRE, Nikolay Lysenko, vice president and executive director of UIRE, Peter Jenelten, vice president of SwissRail, and Michaela Stöckli, CEO of SwissRail, and
- A cooperative agreement between UIRE and Russian Society for Non-Destructive Testing and Technical Diagnostics (ROKOND).

4. The partnership’s representatives have regularly **participated in round-tables** to discuss cooperation between UIRE, UNIFE and FIF, as well as informal meetings and negotiations with members of European delegations.

5. Vice-presidents and representatives of the partnership’s executive directorate **participated in round-tables** devoted to developing locomotive, and passenger coach engineering, as well as work relating to light rail and high-speed technology, and the current general condition of transport research and development.

We understand that this is only the beginning of what promises to be extremely beneficial work from ever greater collaboration with international partners. From these agreements we hope to begin production of new railway engineering equipment which offers enhanced competitiveness, efficiency, and safety. 



## Magnetic levitation: an unknown story from Russia



**Georgy Zobov,**  
Head of Railway Industry Research  
Division, Institute of Natural  
Monopolies Research (IPEM)



**Sergey Belov,**  
Editor of the Railway  
Equipment Journal

Magnetic levitation (maglev) is a concept that is becoming increasingly common in transport applications, with the latest system entering service in Korea earlier this year. Maglev is also the basis of the much-publicized Hyperloop projects. The idea of using a vacuum tube to increase the velocity of the vehicle first appeared at the beginning of the 20th century in a distant city in Siberia. Since then the maglev rolling stock models first developed in Russia have had a significant impact on global projects.

### Birth of the idea

The history of maglev applications in Russian transport systems dates to 1911 when Boris Weinberg, a professor of Tomsk Technological Institute, first introduced a train that utilized electromagnetic suspension and was driven by a linear synchronous motor. The use of electromagnets which eliminated the downward forces required to support the vehicle indicated that magnetic planes were not just a scientific experiment but had the potential for real-life applications.

In the same year, Weinberg built an experimental test bench system which included a small 10kg trailer. This trailer moved in 20-meter copper ring piping which had a diameter of 32cm (Fig. 1). The carriage capsule was suspended under the electromagnets which moved it from one point to another. In 1911-1913, successful experiments were conducted on this stand, which was a significant achievement given the absence of power semiconductor electronics in the early 20th century.

The design of full-scale experimental system foresaw operational speeds of 800-1,000 km/h. The concept relied on installing additional linear motors of 3km in length near

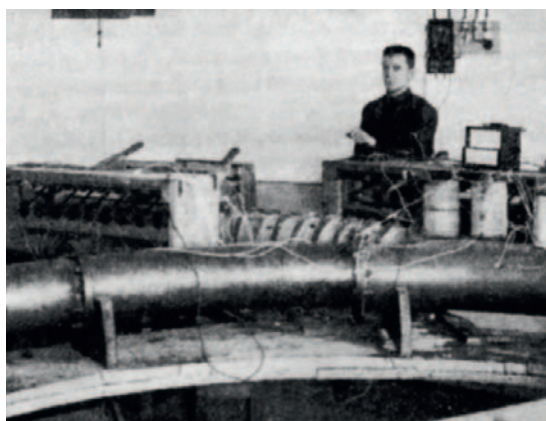

Fig. 1. Boris Weinberg's plant for magnetic road study

each station for acceleration and deceleration. The vehicles would move inside the beam, effectively a hollow tube, which would be in a vacuum in order to reduce the strong air resistance that would result by operating close to the speed of sound.

However, implementation of Weinberg's project did not get off the ground due to a number of technical, economic and political reasons, most notably the outbreak of the First World War in 1914. Russian development of magnetic levitation would not return for another half a century.

### The first practical steps in the USSR

The first practical implementation of a maglev project in Russia took place in the 1970s, when a number of research organizations began to work in this area.

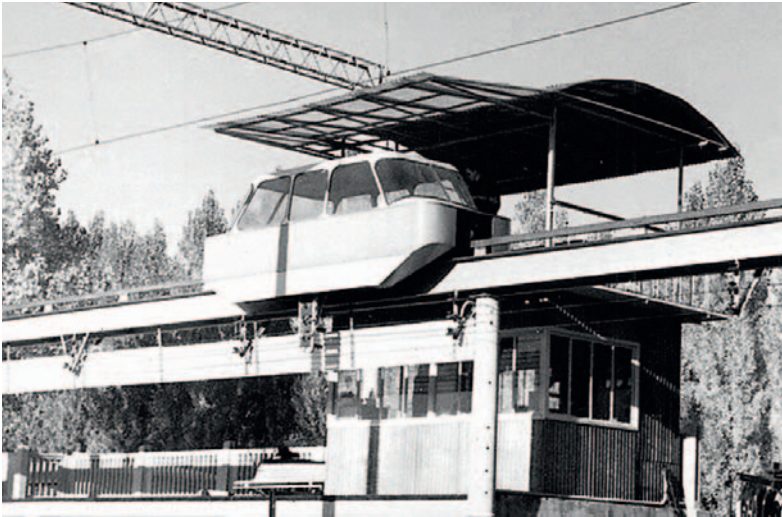

Fig. 2. The world's first railway with a linear traction motor, pictured at the end of the 1960s, Kiev, USSR

Financing of the works was provided within the framework of the USSR state scientific and technical program.

In addition to their designs, many of these research organizations presented their own view of the use of magnetic levitation at transport. In fact, the starting point in the history of maglev technology in the Soviet Union was a project by the Kiev Polytechnic Institute from which the world's first track with linear motor was built and put into operation in 1967 for the trade and industry fair in Kiev (Fig. 2). This demo track lasted until 1971 and stirred international interest in the technology. For example, a delegation

## Projects for urban environment

The decision to build the first Soviet maglev line for commercial operation was made in 1976. The line was planned for the capital of Kazakhstan, Almaty, and would link the city center with new suburban districts.

Engineering and Science Passenger Electromagnetic Transport (ESC TEMP)<sup>1</sup> was created to oversee the implementation of the project. This body subsequently served as the parent organization for environmentally-friendly high-speed transport projects in the USSR and Russia. The transport systems developed by

from East Germany's Ministry of Transport came to study the track. On the basis of experts and enthusiasts involved in this project, Experimental and Design Bureau of Linear Motors (EDB LED) was established in 1971 and continued to conduct maglev research and development work until the collapse of the USSR.

A similar maglev project was developed by the Physics and Energy Institute of the Academy of Sciences of the Latvian SSR in the 1980s, which promised speeds of 500km/h. The vehicle for the project was based on the fuselage of the Il-18 aircraft, and according to the design, it had to weigh 40 tons and accommodate 100 passengers. Cryostats with superconducting magnets were placed under the floor of the vehicle and connected with the body by means of spring suspension system which was designed to minimize the strong disturbance from the track which would occur when operating at 500km/h with a gap between the magnetic field deemed insufficient at these speeds. Frequency converters were controlled by the onboard computer. The vehicle was designed to stop and move to the depot or stabling sections by the mean of wheels which would run on 3m-gauge. The same wheels would be deployed in case of an accident in order to ground the train. The developers built an experimental model of the system, with the vehicles weighing 3.2kg.

ESC TEMP were projected to transport 15,000-20,000 passengers per hour at operating speeds of up to 60km/h in urban conditions, with a maximum vehicle speed of 150km/h, and up to 50 million passengers per year in the suburbs operating at up to 120km/h using vehicles with a maximum speed of 250km/h. With headways of 1min 30s to 10 minutes, operations were comparable to urban traffic intervals. The plan stated that length of the route in a city should not exceed 30km, and 150km in the suburbs. This strategy was considered

<sup>1</sup>Engineering and Scientific Center «Passenger Electromagnetic Transport» (ESC TEMP, Russian abbreviation)

an alternative to developing metro systems for cities with a population of less than one million people.

In 1979, trial operation of a TP-01 vehicle equipped with permanent magnets and a linear electric drive system began on a 36m test section in Moscow (Figure 3).

Permanent magnets were placed in the bottom of the vehicle in 24 parallel rows, with lateral stability provided by the wheels. TP-01 was 9m long, weighed eight tons and could accommodate 35 people. It had a levitation gap of 10-20mm<sup>2</sup>. This pilot batch of linear motors was produced and successfully tested in 1978-1979 in the experimental and design bureau LED.

Tests of the electromagnetic suspension and linear electric drive systems continued at a special testing center at Ramenskoye, near Moscow from 1980 to 1985. During this time the stands were developed, the length of the test track was increased to 850m, and experimental transport plants TP-02 and TP-03 were built both of which weighed of up to three tons. In addition, vehicle-laboratory TP-04 was created in order to utilize a frequency and voltage converter to fine-tune the linear traction electric drive.

The Almaty project was expected to be completed in the first half of the 1980s. However, due to various reasons this did not happen. Moreover, in 1981 the population of the city had reached 1 million, and the focus shifted to constructing a metro system instead. The Kazakhstan project was terminated despite the considerable amount of work that was carried out. However, work on maglev projects continued in ESC TEMP.

In the second half of the 1980s, a 600m pilot maglev monorail was completed at the test center in Ramenskoye. The undercarriage of the maglev vehicle, TP-05, was fitted with an electromagnetic suspension which surrounded the beam (Fig. 4). Thus, the TP-05's design was similar to the vehicle used in the German Transrapid system. It had a capacity of 18 people, and a gross weight of 12 tons. The first successful test of the vehicle was conducted on February 25, 1986.

The vehicle was tested at Ramenskoye throughout 1986 and was viewed by experts



Fig. 3. The first Soviet carriage with magnetic levitation system and linear electric drive



Fig. 4. Carriage TP-05 with electromagnetic levitation and linear electric drive at the experimental proving ground in Ramenskoye

from countries from all over the world including Germany, the United States, Italy, South Korea and Australia. Each delegation noted the high level of work being done. It should be noted that experimental magnetic levitation systems were tested at this time only in Germany and Japan. Thus, the test centre near Moscow became the world's third specialized proving ground for study of maglev technologies.

Following the cancellation of the Almaty project the state's main objective for its maglev program shifted to a project in Armenia. The 3.2km Yerevan–Abovyan line started off as an experimental project with the goal

<sup>2</sup> Different meanings in different sources



of developing a passenger service by 1990. More than 40 organizations and enterprises, and over 10 ministries and agencies with experience of maglev participated in this program. However, following a catastrophic earthquake in Armenia on December 7

1988, which resulted in numerous casualties and significant destruction, the focus of the Armenian construction industry shifted to dealing with the clear-up operation. As a result, funding of the maglev project was stopped and never restarted.

## Magnetic levitation for long distances

In parallel with the urban maglev project, research was conducted into the use of the technology for long-distance applications. In 1977-1978 the Tube 2000 project was developed in Moscow. The project envisaged a train capable of accelerating up to 2,000km/h in a special tube filled with rarefied air. It was hoped that such a train would compete with planes as a viable means of long-distance transport.

However, the main work to develop a long-distance high-speed maglev system which would operate at up to 500km/h was carried out in VNIIZhT MPS<sup>3</sup> and VELNII<sup>4</sup>, a special engineering center created in 1958 at Novocherkassk Electric Locomotive Plant to research and develop designs for new electric locomotives. The main purpose of this work was to develop a high-capacity transport system between the most densely populated areas of the country: from Moscow south to the Crimean Peninsula, and the Caucasus, and from Moscow to Leningrad<sup>5</sup>. Operating

at six-minute headways, the goal was to serve 100,000 passengers per day.

By 1980, VELNII had developed pilot plants, stands and field samples of the major systems required for maglev operation utilizing research carried out at various centers coordinated by VELNII. For example, research on suspension and linear motors was conducted at the Leningrad Polytechnic Institute, while development of cryostat and superconducting electromagnet for electrodynamic suspension took place in Dnipropetrovsk at the Academy of Sciences of the Ukrainian SSR. In 1980, Experimental and Design Bureau LED developed prototypes of unilateral linear induction motors with an 800kW capacity for the project. These motors, a world first, are designed for a nominal speed of 400km/h. In addition, the Polytechnic Institute in Yerevan built a maglev test track along the Hrazdan River, but like the city's project, work here stopped following the earthquake in 1988. A testing center for the pickup systems at high speeds was also built in Omsk.

By 1979, VELNII had developed the chassis for a full-scale maglev vehicle, including the magnetic-plane with superconducting magnets. The train was envisaged to consist of 10 cars with 75 seats in each, and each car would weigh 40 tons. When operating at speeds of less than 60-80km/h, the train had to move on pneumatic-wheel chassis which was then removed similar to landing gear on an aircraft. To solve the problem of the current pickup at high speeds, a plasma current collector (electroarc) and a combined current collector (contact and plasma) were developed. Throughout the course of this work, Experimental and Design Bureau (LED) proposed a new maglev concept.



Fig. 5. Chassis of VELNII magnetic-plane without a body

<sup>3</sup>D All-Union Scientific and Research Institute of Railway Transport of Ministry of Communication Lines (since 2008 - «VNIIZhT» JSC)

<sup>4</sup>All-Union Research and Design Institute of Electric Locomotive Building

<sup>5</sup>The name of St. Petersburg until 1991



This was based on a more modest structure of multi-inductor unilateral linear motor which offered greater resilience in the mechanical connections between the elementary inductors. This created a multi-functional suspension

system that simultaneously provides traction, suspension and, in part, lateral stabilization of the magnetic-plane.

A sample weighing 5 tons was successfully tested and transferred to VELNII (Fig. 5).

## Projects in the 1990s

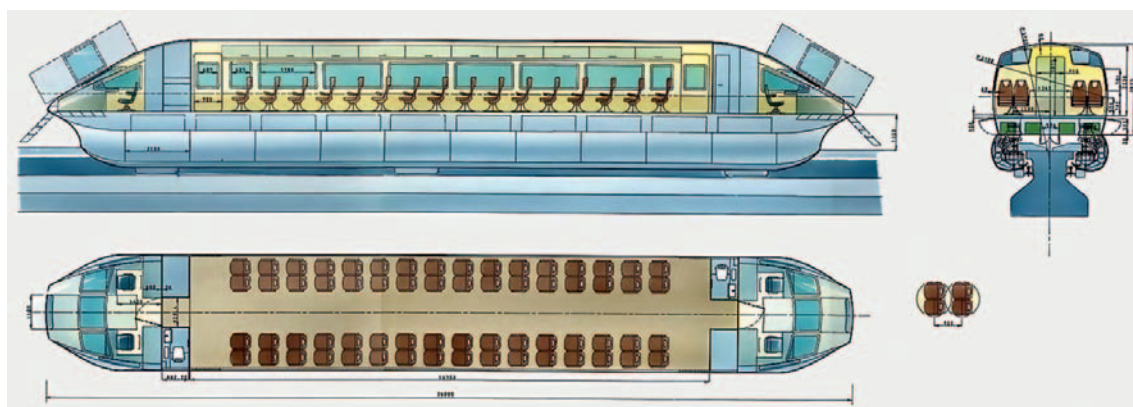

Fig. 6. Construction diagram of the B-250 carriage (ESC TEMP, 1990-1992)

Further development of Russian maglev systems commenced in 1991 when a state scientific and technical program for the development of environmentally-friendly high-speed transport was approved and was planned to run up to 2005. The program included the development of vehicles to use magnetic suspension, and a feasibility study for the construction of a new transport system between Moscow and Sheremetyevo airport. Work was planned to commence on this project in 1992 with the aim of introducing an experimental section in 1995 and the complete line in 1997. The maximum design speed of the 35km line was 250km/h, and it would offer a 15-20-minute journey time.

Since it was founded VELNII has achieved many significant milestones in the development of Russian maglev systems, which includes the design of the B-250 in 1990-92 (Fig. 6). Here the traction device and the magnetic suspension of the vehicle are located under the visor of the track girder to reduce the impact of snow and ice. The B-250 project was significantly different from foreign designs because the track element of the linear motor was located on top of the girder. The gap between the track element and the inductor needs to be very small as even small accumulation of snow or ice could result in failure.

By 1993 all the prerequisites for creation of commercial maglev systems, as well as the theoretical basis for implementation of vacuum tube transport projects, were in place. But the collapse of the Soviet Union, the breakdown of economic relations and severe economic crisis meant that by mid-1993 the funding had been cut meaning that work in this area virtually stopped despite the high level of technical development.

Nevertheless, ESC TEMP's work continued although rather than maglev, this predominately focused on creating and improving a linear asynchronous drive system. ESC TEMP's work was consequently used to develop a monorail system for Moscow, operation of which began in 2004, and which like its later maglev developments, was designed to work effectively in difficult climatic conditions.

ESC TEMP's electric drives are now in use in various high-tech industries as they generate virtually no dust. In addition, Russian achievements in the field of magnetic levitation have found favor in international applications, most notably the Transrapid magnetic levitation trains which provide a passenger service between Pudong International Airport in Shanghai and the city center. (S)

# ExpoCityTrans 2016

## YOUR TICKET TO A SEAMLESS FUTURE

[www.expocitytrans.com](http://www.expocitytrans.com)

November 29 - December 1, 2016  
Pavilion 75, VDNH, Moscow, Russia

### Organizers



Mosgortrans



Moscow Metro

### Supported by



Ministry of Transport  
of the Russian Federation



ПРАВИТЕЛЬСТВО  
МОСКВЫ

### Operator





**EXPO**  
**1520**



THE SIXTH  
INTERNATIONAL  
FAIR OF RAILWAY  
**EQUIPMENT AND TECHNOLOGIES**

**21-24 JUNE 2017**

Russia, Moscow, Shcherbinka,  
Experimental Ring VNIIZhT

advertising

General Partner

**РЖД** Russian Railways

JSC Russian Railways

Organizer



[WWW.EXPO1520.RU](http://WWW.EXPO1520.RU)



INSTITUTE OF NATURAL MONOPOLIES RESEARCH



RAILWAY INDUSTRY  
RAIL TRANSPORT  
ENERGY INDUSTRY

ANALYSIS  
STATISTICS  
RESEARCH  
FORECASTS  
REVIEWS



Malaya Bronnaya st., 2/7, bld. 1, Moscow, 123104, Russia  
Phone: +7 495 690-00-56; fax: +7 495 603-61-11  
[ipem@ipem.ru](mailto:ipem@ipem.ru), [www.ipem.ru](http://www.ipem.ru)